

TOTAL
PRODUCTS
CATALOG

KDS

MURATEC-KDS CORP.



Quality

Environment

Customer service & Delivery service



Certified
ISO 9001
JQA-1564

MURATEC-KDS CORP.



Certified
ISO 9001
JQA-QMA11691

KDS MANUFACTURING (M) SDN BHD

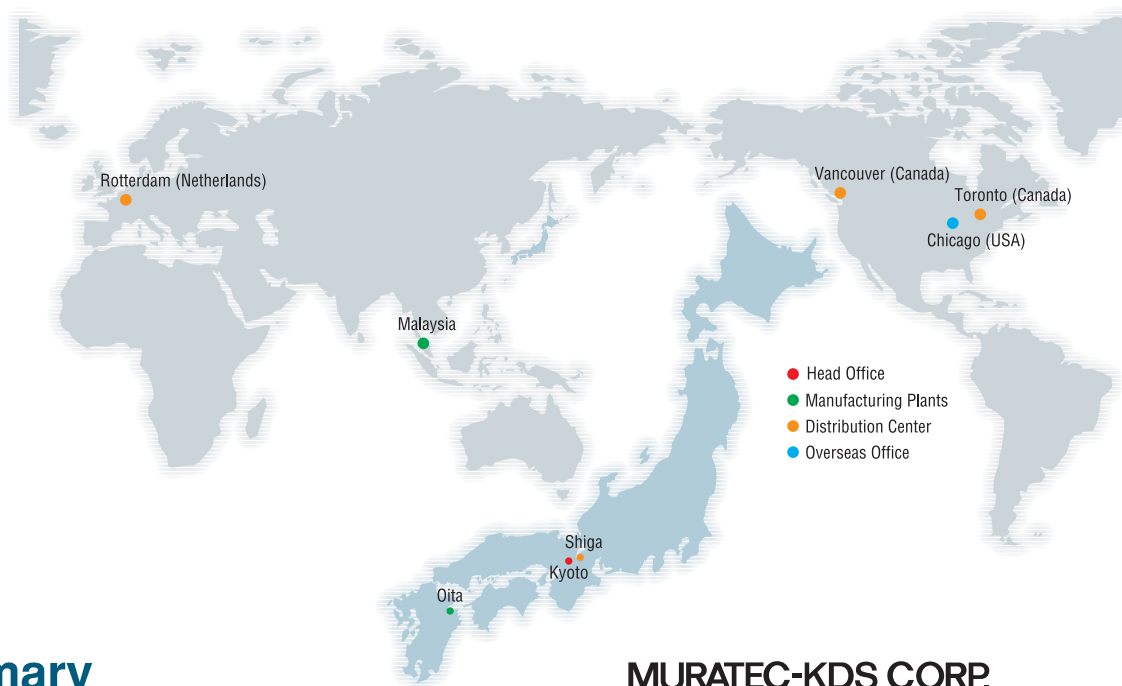

Summary

Company name	MURATEC-KDS CORP.
President and C.E.O Head Office	Norio Matsubayashi 39, Matsuda-cho, Higashi-kujo, Minami-ku, Kyoto, 601-8036, JAPAN
Date of Establishment	1937
Capitalization	100 million yen
No. of employees	150
Sales office	Niigata, Tokyo, Nagoya, Kyoto, Hyogo and Fukuoka
Manufacturing factories	Oita (JAPAN), KDS Malaysia (MALAYSIA)
Distribution Center	Shiga, Rotterdam, Vancouver and Toronto
Overseas Office	Chicago (USA)
Co-operated overseas manufactures	STABILA (GERMANY) SORTIMO (GERMANY) SUNSHINE MAKERS (USA)
ISO Certified	ISO 9001 JQA-1564 (MURATEC-KDS Corp.) ISO 9001 JQA-QMA11691 (KDS Malaysia)

MURATEC-KDS CORP.

MURATEC-KDS CORPORATION HEAD OFFICE
No.39, Matsuda-cho, Higashi-kujo, Minami-ku, Kyoto
601-8036, JAPAN
TEL. +81-75-681-2761 FAX. +81-75-661-2764
E-mail : mailto@muratec-kds.jp

Muratec-KDS, a division of Murata Machinery USA, Inc.
2026 West Cortez St. Chicago, IL60622-3630 U.S.A
TEL. +1-773-252-1314 FAX. +1-773-252-1319
E-mail: kevin.carter.kds@muratec-usa.com

KDS Manufacturing (M) Sdn Bhd
Lot 7963, Batu 22, Jalan Air Hitam,
81000 Kulai, Johor, Malaysia
E-mail: sales@kds-ml.com.my

<http://www.muratec-kds.jp/en/>

Display Stands

E-type Stand ▶

15 pcs of hook

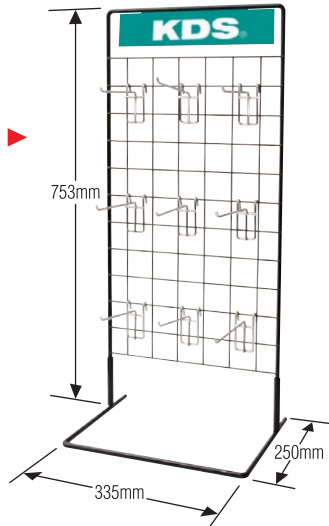

C-type Stand ▶

35 pcs of hook

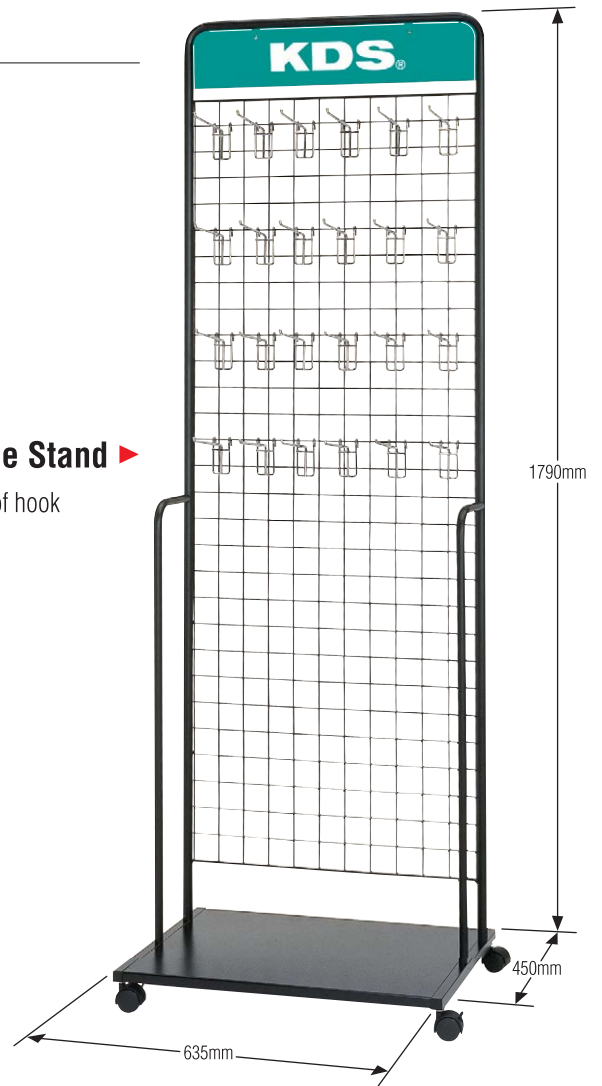

JAPAN DIY HOMECENTER SHOW 2014

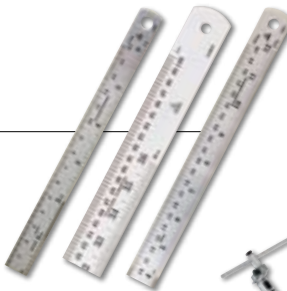
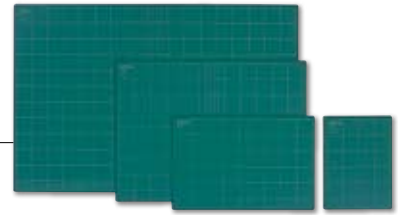
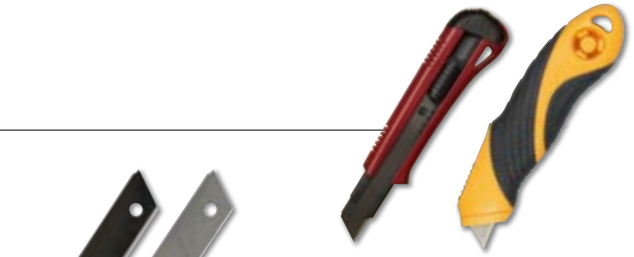

Cutters**Spare Blades****Safety - Bases****Scissors****Scrapers****Other Tools****Poket Tapes****Long Tapes****Electronic Products****Surveys****Wooden Chisels / Planers**

Cutters

KDS



Feel the difference ! KDS cutters are unique !

1. EXTRA BLADES INCLUDED

Use up your blade on the job ?

Just open end cap and pull out spare blade !

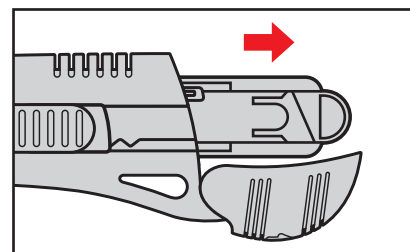
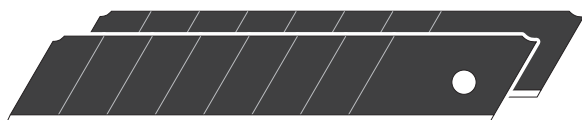

2. CHOOSE YOUR LOCK

Select the lock that you prefer : Auto-lock, Screw lock, or Safety lock.
All locks hold the blade securely.

Auto-Lock

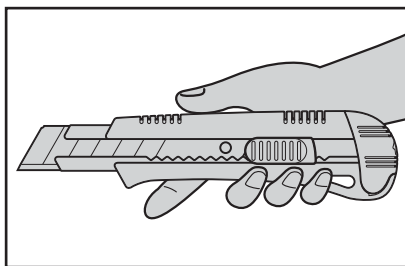

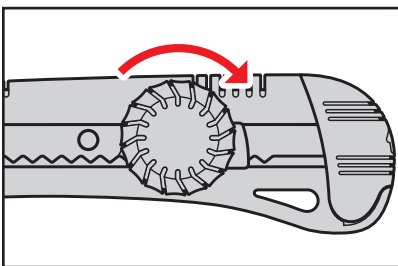

Screw Lock

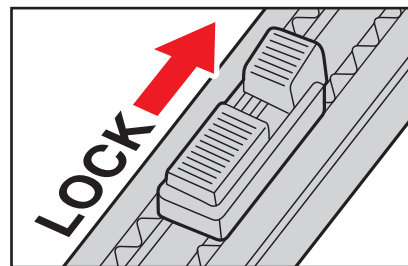

Safety Lock



 × 3 (1+2) : Come with 3 blade(s)

 : Blister Packed

 : Plastic Bag



: With Power Black Evolution Blade(s)

 : Paper Box

Cutters

L-18EL 雅 (Mi-Ya-Bi) The Elegance RE BL

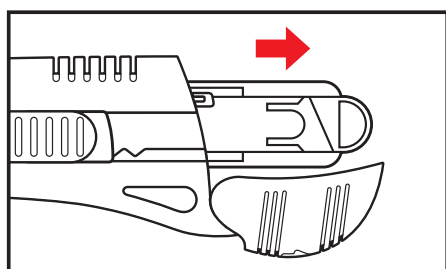

Why must hand tools be so plain? Add style to your tools with the KDS 雅(Mi-Ya-Bi), which means "The Elegance". With the KDS 雅(Mi-Ya-Bi), be proud to express your personality and stand out in the crowd!

1 spare blade stored in the handle.



Cat.No.	Handle color	Suitable blade	QTY/Box	QTY/ Carton	N.W. (kgs)	G.W. (kgs)	M3	Carton size (Cm) D x W x H	EAN	Stock available in Rotterdam
L-18EL RE	Metallic Red	LB-10B EVO	10	60	6	8	0.033	37 x 48.5 x 18.3	4954183 525262	×
L-18EL BL	Metallic Blue								4954183 525279	

Cutters Package-Deals

LC-405 5H

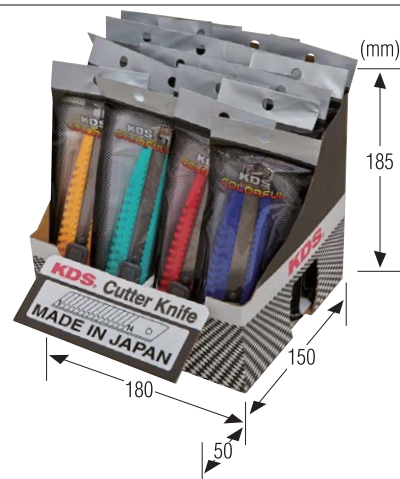

"Safety-Lock" 4 colors assorted.
Supplied with 1 piece of 15 segments spare blade.

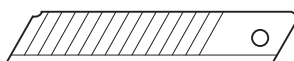

Cat.No.	Handle color	Suitable blade	QTY/Box	QTY/ Carton	N.W. (kgs)	G.W. (kgs)	M3	Carton size (Cm) D x W x H	EAN	Stock available in Rotterdam
LC-405 5H	Blue, Green, Yellow and Red (each 5 pcs. Per set)	LB-10W EVO	20	80	8	10	0.026	32 x 38.3 x 21.2	4954183 527501	○

L-18 5H



"Auto-Lock" 4 colors assorted.
Supplied with 1 piece of 15 segments blade.
Without spare blade and spare blade holder.

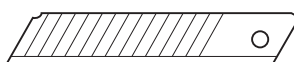

Cat.No.	Handle color	Suitable blade	QTY/Box	QTY/ Carton	N.W. (kgs)	G.W. (kgs)	M3	Carton size (Cm) D x W x H	EAN	Stock available in Rotterdam
L-18 5H	Blue, Green, Yellow and Red (each 5 pcs. Per set)	LB-10W EVO	20	80	7	9	0.026	32 x 38.3 x 21.2	4954183 527495	○

L-19 5H



"Twist-Lock" 4 colors assorted.
Supplied with 1 piece of 15 segments blade.
Without spare blade and spare blade holder.

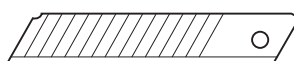

Cat.No.	Handle color	Suitable blade	QTY/Box	QTY/ Carton	N.W. (kgs)	G.W. (kgs)	M3	Carton size (Cm) D x W x H	EAN	Stock available in Rotterdam
L-19 5H	Blue, Green, Yellow and Red (each 5 pcs. Per set)	LB-10W EVO	20	80	7	9	0.026	32 x 38.3 x 21.2	4954183 527488	○

Package-Deals

H-12YE-3B Job Boss Pro Value pack



Heavy-duty knife with strong ABS plastic body.
Screw type slider securely locks the blade in place.

3 Bonus blades in a storage case.



18 knives in a display box

Cat.No.	Handle color	Suitable blade	QTY/Box	QTY/ Carton	N.W. (kgs)	G.W. (kgs)	M3	Carton size (Cm) D x W x H	EAN	Stock available in Rotterdam
H-12YE-3B	Yellow	HB-10B EVO	18	18	5	7	0.031	25.5 x 42 x 28.5	4954183 511500	×

S-20 Easy Slim



Small size of display box may fit placing near the register or other narrow place.

It comes with ONE Power Black Blade to assure sharp cutting.



Cat.No.	Handle color	Suitable blade	QTY/Box	QTY/ Carton	N.W. (kgs)	G.W. (kgs)	M3	Carton size (Cm) D x W x H	EAN	Stock available in Rotterdam
S-20	Blue, Green, Yellow, Red, White and Orange (each 4 pcs. Per set)	SB-10B EVO	24	120	2.5	3	0.012	24 x 29.3 x 16	4954183 525361	○

Cutters

25 mm

Extra Heavy Duty blades

H-Blades

H-Blades are 40% thicker than standard L-Blades.
Recommended for cutting tough materials like plaster board.

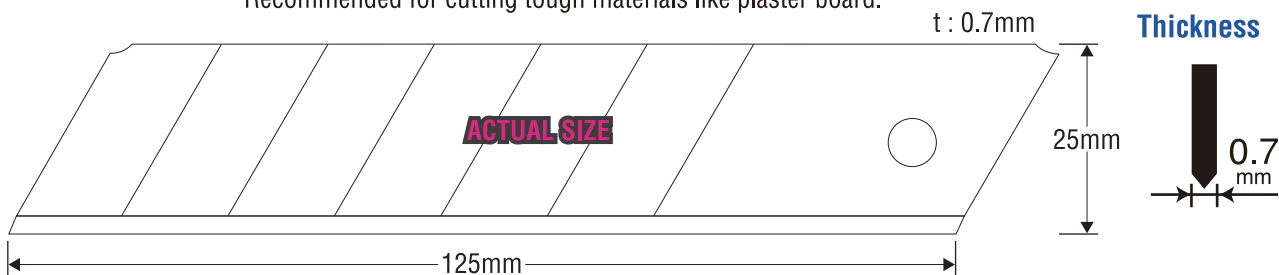

Application : for all H-type cutters H-11 H-12 H-12YE-3B H-13



G-18 mm

Heavy Duty PRO blades

G-Blades

G-Blades are 20% thicker than standard L-Blades and suit for more solid job.
Other dimensions are same as L-Blades.

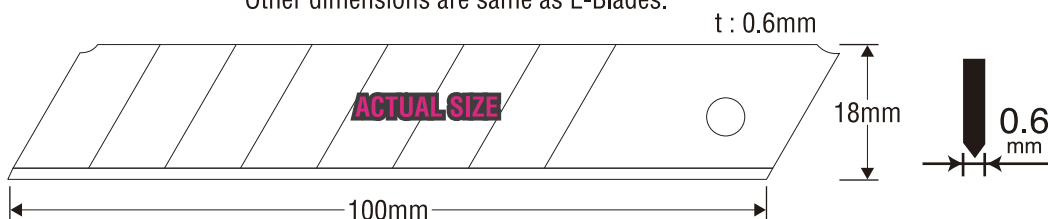

Application : for all G-type cutters and GG scrapers (SCL-200 SCL-300 and SCL-600)



18 mm

Heavy Duty blades

L-Blades



Application : for all L-type cutters and GG scrapers (SCL-200 SCL-300 and SCL-600)



9 mm

Standard Duty blades

S-Blades

S-Blade is most popular standard cutter for general cutting.

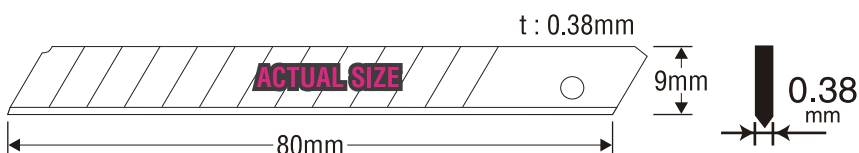

Application : for S-11 S-12 S-13 S-14 S-20



Cutters

**25
mm**

H-Blades

H-Blades are 40% thicker than standard L-Blades.
Recommended for cutting tough materials like plaster board.

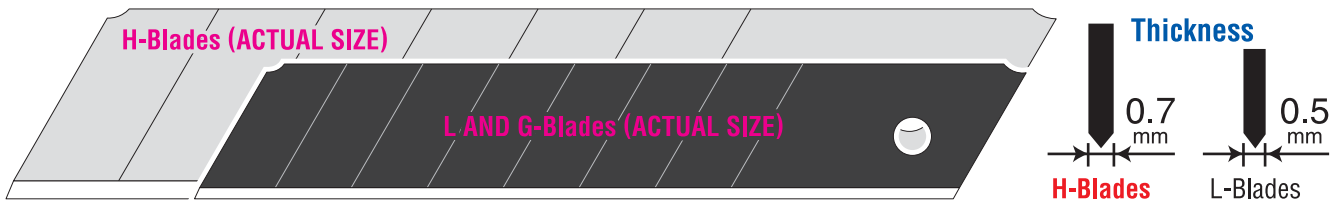

H-11 Job Boss

YE RE

Super heavy duty knife with soft rubber grip.
Screw type slider securely locks the blade in place.

Cat.No.	Handle color	Suitable blade	QTY/Box	QTY/Carton	N.W.(kgs)	G.W.(kgs)	M3	Carton size (Cm) D x W x H	EAN	Stock available in Rotterdam
H-11YE	Yellow	HB-10 EVO	10	100	20	22	0.079	43.3 x 68 x 26.8	4954183 542252	○
H-11RE	Red								4954183 542245	

H-12 Job Boss Pro

YE RE

EVO
Power Black Protection

Heavy-duty knife with strong ABS plastic body.
Supplied with **one Power Black H-Blade**.

Cat.No.	Handle color	Suitable blade	QTY/Box	QTY/Carton	N.W.(kgs)	G.W.(kgs)	M3	Carton size (Cm) D x W x H	EAN	Stock available in Rotterdam
H-12YE	Yellow	HB-10B EVO	10	100	18	20	0.080	34.8 x 76.3 x 30	4954183 561222	○
H-12RE	Red								4954183 561345	

H-13 Job Boss SoftGrip

EVO
Power Black Protection

Heavy-duty knife with elastomer body.
Supplied with **one Power Black H-Blade**. Screw type slider securely locks the blade in place.

Cat.No.	Handle color	Suitable blade	QTY/Box	QTY/Carton	N.W.(kgs)	G.W.(kgs)	M3	Carton size (Cm) D x W x H	EAN	Stock available in Rotterdam
H-13	Gray	HB-10B EVO	10	100	17	19	0.080	34.8 x 76.3 x 30	4954183 561260	○

Cutters

G-18 mm

G-Blades

G-Blades are 20% thicker than standard L-Blades and suit for more solid job. Other dimensions are same as L-Blades.

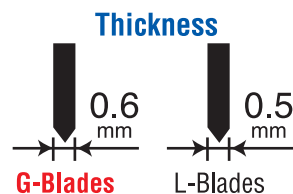
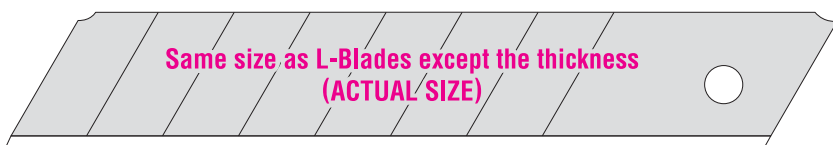

G-11 Safety G

YE RE

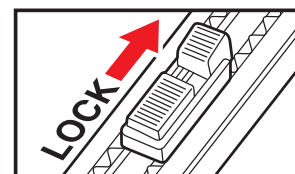
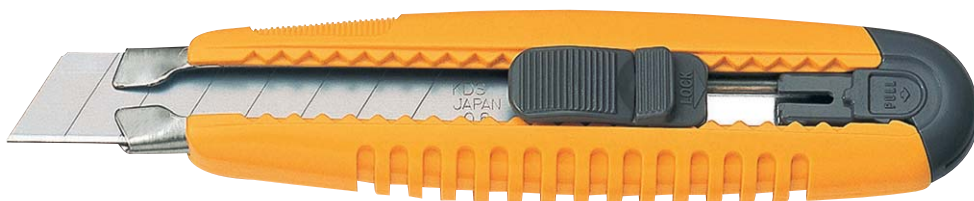

Extra heavy-duty texture for long use and good grip with **0.6mm thick blade**. With **2 spare blades stored in the handle**.

Cat.No.	Handle color	Suitable blade	QTY/Box	QTY/Carton	N.W.(kgs)	G.W.(kgs)	M3	Carton size (Cm) D x W x H	EAN	Stock available in Rotterdam
G-11YE	Yellow	GB-10 EVO	10	100	11	13	0.049	32 x 61 x 25	4954183 542290	○
G-11RE	Red								4954183 542276	

GC-401



Extra heavy-duty texture for long use and good grip with **0.6mm thick blade**. With **2 spare blades stored in the handle**.

Cat.No.	Handle color	Suitable blade	QTY/Box	QTY/Carton	N.W.(kgs)	G.W.(kgs)	M3	Carton size (Cm) D x W x H	EAN	Stock available in Rotterdam
GC-401	Orange	GB-10 EVO	20	200	22	24	0.054	36.8 x 55.3 x 26.5	4954183 515416	○

G-14 AutoFeeder



Ergonomically designed with soft rubber touch grip with **0.6mm thick blade**. Holds 6 blades. **Comes with 6 G-blades in a Safety pack**.

Cat.No.	Handle color	Suitable blade	QTY/Box	QTY/Carton	N.W.(kgs)	G.W.(kgs)	M3	Carton size (Cm) D x W x H	EAN	Stock available in Rotterdam
G-14	Yellow	GP-6 EVO	10	100	14	16	0.079	43.3 x 68 x 26.8	4954183 555078	×

Cutters

Grip Fit Series



Rubberized, Non-Slip Grip

2 spare blades stored in the handle.

G-15 Grip Fit AutoLock G



Rubberized, non-slip grip cutter with automated locking slider.

Supplied with 0.6mm thick Power Black Blades. **2 spare blades stored in the handle.**

Cat.No.	Handle color	Suitable blade	QTY/Box	QTY/Carton	N.W.(kgs)	G.W.(kgs)	M3	Carton size (Cm) D x W x H	EAN	Stock available in Rotterdam
G-15	Yellow	GB-10B EVO	10	100	12	14	0.068	36.3 x 76 x 24.5	4954183 561512	○

G-16 Grip Fit TwistLock G



Rubberized, non-slip grip cutter with twist locking slider.

Supplied with 0.6mm thick Power Black Blades. **2 spare blades stored in the handle.**

Cat.No.	Handle color	Suitable blade	QTY/Box	QTY/Carton	N.W.(kgs)	G.W.(kgs)	M3	Carton size (Cm) D x W x H	EAN	Stock available in Rotterdam
G-16	Yellow	GB-10B EVO	10	100	12	14	0.068	36.3 x 76 x 24.5	4954183 561529	○

Cutters

18 mm L-Blades

L-11 Safety L YE RE



L-11YE

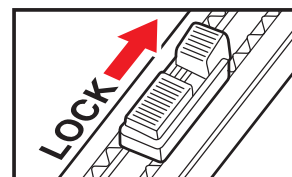

L-11RE

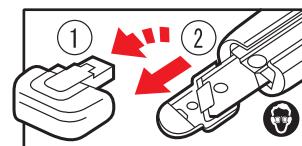

L-11B



One-handed safety lock. Supplied with **2 spare blades stored in the handle.**

Cat.No.	Handle color	Suitable blade	QTY/Box	QTY/Carton	N.W.(kgs)	G.W.(kgs)	M3	Carton size (Cm) D x W x H	EAN	Stock available in Rotterdam
L-11YE	Yellow	LB-10 EVO	10	100	11	13	0.049	32 x 61 x 25	4954183 542320	○
L-11RE	Red								4954183 548827	
L-11B	Black	LB-10B EVO							4954183 507213	×

LC-405

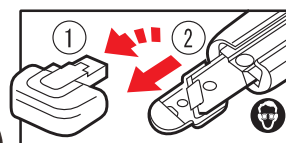

One-handed safety lock. Supplied with **2 spare blades stored in the handle.**



Cat.No.	Handle color	Suitable blade	QTY/Box	QTY/Carton	N.W.(kgs)	G.W.(kgs)	M3	Carton size (Cm) D x W x H	EAN	Stock available in Rotterdam
LC-405	Orange	LB-10 EVO	20	200	20	22	0.054	36.8 x 55.3 x 26.5	4954183 515614	×

Cutters

L-15 Big Twist

YE RE

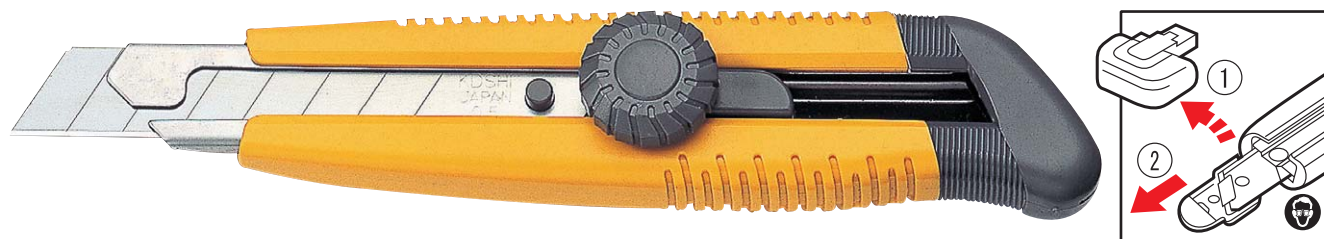

Multi-purpose screw type cutter for professional use, with **2 spare blades stored in the handle.**

Cat.No.	Handle color	Suitable blade	QTY/Box	QTY/Carton	N.W.(kgs)	G.W.(kgs)	M3	Carton size (Cm) D x W x H	EAN	Stock available in Rotterdam
L-15YE	Yellow	LB-10 EVO	10	100	12	14	0.079	43.3 x 68 x 26.8	4954183 542238	○
L-15RE	Red								4954183 542214	×

L-17 Auto Feeder

YE RE



Innovation system allowing 8 blades concealed in this compact body.

Ergonomically designed L-17 is comfortable and safe to use. **Comes with 8 L-blades in a Safety pack.**

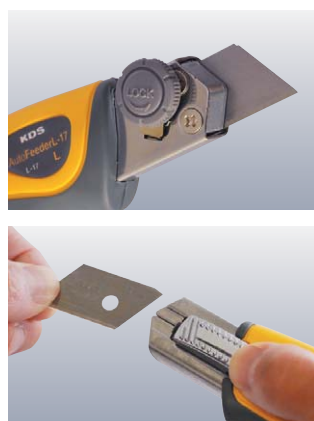

L-17 **L-Blades** x 8



G-14 **G-Blades** x 6

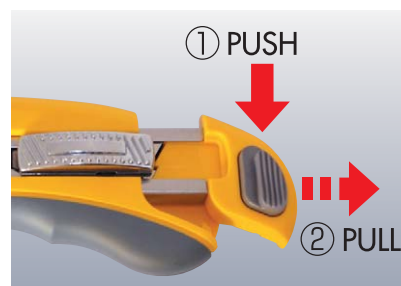

Cat.No.	Handle color	Suitable blade	QTY/Box	QTY/Carton	N.W.(kgs)	G.W.(kgs)	M3	Carton size (Cm) D x W x H	EAN	Stock available in Rotterdam
L-17YE	Yellow	LP-32	10	100	20	22	0.079	43.3 x 68 x 26.8	4954183 548964	○
L-17RE	Red								4954183 548957	×

Cutters

L-18 Auto Lock

YE RE BK

 × 3 (1+2) 

L-18YE

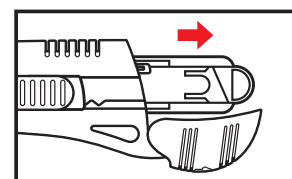

L-18RE



L-18YEB



L-18B



"Auto-Lock" cutter with automated locking slider. Supplied with **2 spare blades stored in the handle.**

Cat.No.	Handle color	Suitable blade	QTY/Box	QTY/Carton	N.W.(kgs)	G.W.(kgs)	M3	Carton size (Cm) D x W x H	EAN	Stock available in Rotterdam
L-18YE	Yellow	LB-10 EVO	10	100	11	13	0.068	36.3 x 76 x 24.5	4954183 554064	○
L-18RE	Red								4954183 554057	
L-18YEB	Yellow	LB-10B EVO	10	100	11	13	0.068	36.3 x 76 x 24.5	4954183 522049	×
L-18B	Black								4954183 507237	

Cutters

L-19 Twist L

YE RE BK

 × 3 (1+2) 

L-19YE

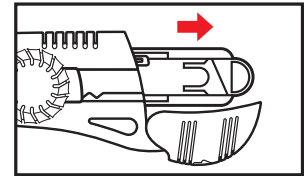

L-19RE



L-19YEB



L-19B



"Twist-Lock" for safe and secure cutting. With **2 spare blades stored in the handle.**

Cat.No.	Handle color	Suitable blade	QTY/Box	QTY/Carton	N.W.(kgs)	G.W.(kgs)	M3	Carton size (Cm) D x W x H	EAN	Stock available in Rotterdam
L-19YE	Yellow	LB-10 EVO	10	100	11	13	0.068	36.3 x 76 x 24.5	4954183 554088	○
L-19RE	Red								4954183 554071	×
L-19YEB	Yellow	LB-10B EVO	10	100	11	13	0.068	36.3 x 76 x 24.5	4954183 522056	×
L-19B	Black								4954183 507206	

Cutters

L-18SS STAINLESS Blade AutoLock



Auto-lock cutter with STAINLESS BLADE.

This knife is recommended for outdoor or wet working environments.

Metal-finished body highlights the stainless blade and creates a new image for KDS cutters.



Perfect for WET environments



Stainless steel blade

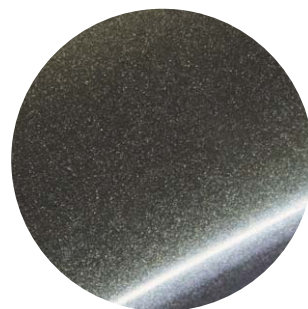

Metal-finished body

Cat.No.	Handle color	Suitable blade	QTY/Box	QTY/Carton	N.W.(kgs)	G.W.(kgs)	M3	Carton size (Cm) D x W x H	EAN	Stock available in Rotterdam
L-18SS	Metallic	LB-5S EVO	10	100	10	12	0.068	36.3 x 76 x 24.5	4954183 521554	○

L-21 Auto Feeder



L-21YE



L-21RE



A three-blade, auto-feeding magazine to keep a sharp edge for a longer time. **Three L-blades pre-loaded.**

Auto-lock for regular use and a pro screw lock for power cuts.

Both LB blade(0.5mm thickness) and GB blade(0.6mm thickness) fits the body.

Cat.No.	Handle color	Suitable blade	QTY/Box	QTY/Carton	N.W.(kgs)	G.W.(kgs)	M3	Carton size (Cm) D x W x H	EAN	Stock available in Rotterdam
L-21YE	Yellow	LB-10 EVO and	10	100	12	14	0.079	32 x 61x 25	4954183 559946	○
L-21RE	Red	GB-10 EVO							4954183 559953	×

Cutters

Grip Fit Series



L-22 GripFit AutoLock L



Rubberized, non-slip grip cutter with automated locking slider. Supplied with Power Black Blades.

2 spare blades stored in the handle.

Cat.No.	Handle color	Suitable blade	QTY/Box	QTY/Carton	N.W.(kgs)	G.W.(kgs)	M3	Carton size (Cm) D x W x H	EAN	Stock available in Rotterdam
L-22	Yellow	LB-10B EVO	10	100	14	16	0.068	36.3 x 76 x 24.5	4954183 509132	○

L-23 GripFit TwistLock L



Rubberized, non-slip grip cutter with twist lock slider. Supplied with Power Black Blades. **2 spare blades stored in the handle.**

Cat.No.	Handle color	Suitable blade	QTY/Box	QTY/Carton	N.W.(kgs)	G.W.(kgs)	M3	Carton size (Cm) D x W x H	EAN	Stock available in Rotterdam
L-23	Yellow	LB-10B EVO	10	100	14	16	0.068	36.3 x 76 x 24.5	4954183 509149	○

Cutters

MultiPro Series



L-24 MultiPro AutoLock L



"MultiPro L series" is not only for cutting.

Can be used for tucking carpet, prying lids off paint and other cans,

and scoring & cut cardboard to make boxes. Supplied with **One Power Black Blade.**

Cat.No.	Handle color	Suitable blade	QTY/Box	QTY/Carton	N.W.(kgs)	G.W.(kgs)	M3	Carton size (Cm) D x W x H	EAN	Stock available in Rotterdam
L-24	Yellow	LB-10B EVO	10	100	8	10	0.068	36.3 x 76 x 24.5	4954183 510749	○

L-25 MultiPro TwistLock L



"MultiPro L series" is not only for cutting.

Can be used for tucking carpet, prying lids off paint and other cans,

and scoring & cut cardboard to make boxes. Supplied with **One Power Black Blade.**

Cat.No.	Handle color	Suitable blade	QTY/Box	QTY/Carton	N.W.(kgs)	G.W.(kgs)	M3	Carton size (Cm) D x W x H	EAN	Stock available in Rotterdam
L-25	Yellow	LB-10B EVO	10	100	8	10	0.068	36.3 x 76 x 24.5	4954183 510756	○

Cutters

L-30 Finger Guard



Recommendable for professionals as well as DIY users.
Finger protection arm stabilizes cutting depth and prevent from skidding of knife in your palm.

Screw type slider securely locks the blade in place.

Supplied with Power Black Blades. **2 spare blades stored in the handle.**

Good fit with SAW blade(HSB) to cut Wood and Plasterboard.

Cat.No.	Handle color	Suitable blade	QTY/Box	QTY/Carton	N.W.(kgs)	G.W.(kgs)	M3	Carton size (Cm) D x W x H	EAN	Stock available in Rotterdam
L-30	Yellow	LB-10B EVO	10	100	10	12	0.068	38.8 x 85 x 26	4954183 561604	×

RT-45 Grip Fit Rotary 45



The most popular size, 45mm blade rotary cutter with ergonomic, non-slip grip.

Ideal for both left- and right handed use without reassembling the cutter.

Through the pressure on the blade, the unique blade guard adjusts its angle automatically.

Push the slider to the CLOSE position without having to set the blade guard back to the central position.

A straight 45mm blade pre-loaded.

Spare blade



RTB-45

t: 0.3mm

DIA: 45mm

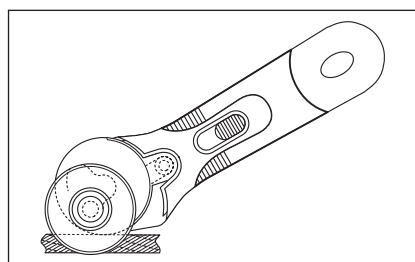

Cat.No.	Handle color	Suitable blade	QTY/Box	QTY/Carton	N.W.(kgs)	G.W.(kgs)	M3	Carton size (Cm) D x W x H	EAN	Stock available in Rotterdam
RT-45	Yellow	RTB-45	12	96	10	11	0.049	26 x 50 x 38	4954183 524647	○
Cat.No.	Number of blades in a case	QTY/Box	QTY/Carton	N.W.(kgs)	G.W.(kgs)	M3	Carton size (Cm) D x W x H	EAN	Stock available in Rotterdam	
RTB-45	1	50	300	3.7	4.5	0.021	24 x 36 x 24	4954183 524654	○	

Cutters

**9
mm**

S-Blades

S-Blade is most popular standard cutter for general cutting.

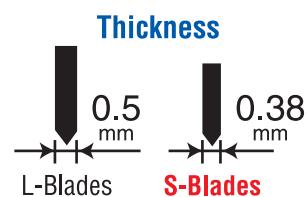
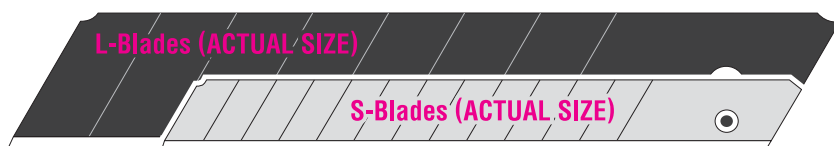

S-11 Stainless Slim



Stainless frame with sliding lock. One slide position matches every break point of the multiple break-off blade.
With **2 stainless steel spare blades**.

Cat.No.	Handle color	Suitable blade	QTY/Box	QTY/Carton	N.W.(kgs)	G.W.(kgs)	M3	Carton size (Cm) D x W x H	EAN	Stock available in Rotterdam
S-11	Silver	SB-10S EVO	10	200	12	16	0.046	24.5 x 43 x 44	4954183 542023	○

S-12 Metal Slim



Stainless frame with sliding lock. One slide position matches every break point of the multiple break-off blade.
With **2 spare blades**.

Cat.No.	Handle color	Suitable blade	QTY/Box	QTY/Carton	N.W.(kgs)	G.W.(kgs)	M3	Carton size (Cm) D x W x H	EAN	Stock available in Rotterdam
S-12	Silver	SB-10 EVO	10	200	12	16	0.046	24.5 x 43 x 44	4954183 542016	○

S-13 Dura Slim

BL GR

S-13BL



S-13GR



Electronic powder coated metal frame with sliding lock. 9 mm snap-off with 13 segments. With **2 spare blades**.

Cat.No.	Handle color	Suitable blade	QTY/Box	QTY/Carton	N.W.(kgs)	G.W.(kgs)	M3	Carton size (Cm) D x W x H	EAN	Stock available in Rotterdam
S-13BL	Blue	SB-10 EVO	10	200	6	8	0.048	22.5 x 48.5 x 44	4954183 542047	○
S-13GR	Green								4954183 542061	

Cutters

S-14 Pocket Slim

YE GR BL

 × 3 (1+2)

S-14YE



S-14BL



S-14GR



S-14YEB



Impact resistant body in high-quality ABS material, with metal blade sleeve. 9 mm snap-off with 13 segments.
With **2 spare blades**.

Cat.No.	Handle color	Suitable blade	QTY/Box	QTY/Carton	N.W.(kgs)	G.W.(kgs)	M3	Carton size (Cm) D x W x H	EAN	Stock available in Rotterdam
S-14YE	Yellow	SB-10 EVO	10	200	6	8	0.046	24.5 x 43 x 44	4954183 542108	○
S-14BL	Blue								4954183 542092	
S-14GR	Green								4954183 542115	
S-14YEB	Yellow								4954183 521363	

Non - SPARE BLADE

YE BL

 × 1

S-14YE NB



S-14BL NB



Impact resistant body in high-quality ABS material, with metal blade sleeve. 9 mm snap-off with 13 segments.
Without spare blade.

Cat.No.	Handle color	Suitable blade	QTY/Box	QTY/Carton	N.W.(kgs)	G.W.(kgs)	M3	Carton size (Cm) D x W x H	EAN	Stock available in Rotterdam
S-14YE NB	Yellow	SB-10 EVO	10	200	6	8	0.046	24.5 x 43 x 44	4954183 525316	×
S-14BL NB	Blue								4954183 525323	

Cutters

S-18 Slim Trim

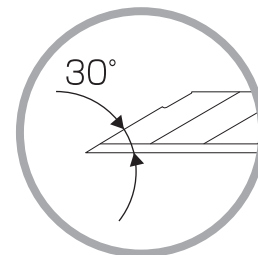

Snap-Edge Cutter is most convenient for delicate cutting work, with special **30 degree angle blade**.

Suitable blade : VB-10 EVO

Cat.No.	Handle color	Suitable blade	QTY/Box	QTY/Carton	N.W.(kgs)	G.W.(kgs)	M3	Carton size (Cm) D x W x H	EAN	Stock available in Rotterdam
S-18	Silver	VB-10 EVO	10	200	12	16	0.054	24.5 x 43 x 44	4954183 553692	○

D-12 Easy Grip



Most useful and convenient for all graphic work. Soft grip allows for precise use, and 10.5mm diameter body for tireless grip. With **16 pcs spare blades**.

Cat.No.	Handle color	Suitable blade	QTY/Box	QTY/ Carton	N.W. (kgs)	G.W. (kgs)	M3	Carton size (Cm) D x W x H	EAN	Stock available in Rotterdam
D-12BL	Blue	DB-48	10	200	4	6	0.048	22.5 x 48.5 x 44	4954183 555054	○
D-12YE	Yellow								4954183 557904	
D-12GR	Green								4954183 555061	

P-11 Plasti Cutter

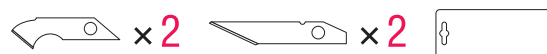

P-11YE



P-11RE

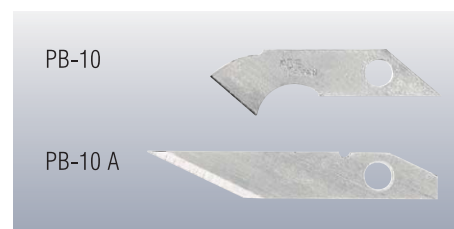

P-Cutter is most convenient for plastic cutting.

2 straight and 1 hook blades stored in the handle.

Cat.No.	Handle color	Suitable blade	QTY/Box	QTY/ Carton	N.W. (kgs)	G.W. (kgs)	M3	Carton size (Cm) D x W x H	EAN	Stock available in Rotterdam
P-11YE	Yellow	PB-10 (Hook blade)/ PB-10A (Sharper)	10	100	5	7	0.049	32 x 61 x 25	4954183 542375	×
P-11RE	Red								4954183 542368	

Cutters

T-11 Threeway

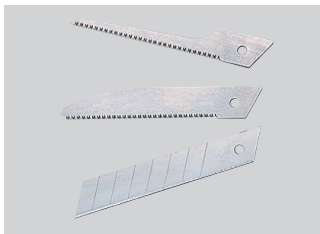
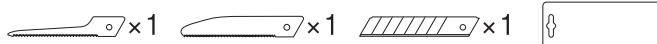
YE
RE

Multi-purpose cutter and standard / keyhole saws.
Most useful for electricians, carpenters and gardeners.

Cat.No.	Handle color	Suitable blade	QTY/Box	QTY/ Carton	N.W. (kgs)	G.W. (kgs)	M3	Carton size (Cm) D x W x H	EAN	Stock available in Rotterdam
T-11YE	Yellow	All L-type blades, HSB-Z and HSB-W	5	50	9	11	0.062	39.3 x 47 x 33.3	4954183 542399	×
T-11RE	Red								4954183 542382	

T-14 Standard Saw



A small portable saw with tucker for general or specific purposes.
Most convenient for electricians and carpenters.
The standard saw blade, which is made from steel, cuts general materials such as wood and plastic pipe.

Cat.No.	Handle color	Suitable blade	QTY/Box	QTY/ Carton	N.W. (kgs)	G.W. (kgs)	M3	Carton size (Cm) D x W x H	EAN	Stock available in Rotterdam
T-14	Yellow	HSB-Z and HSB-W	10	100	8	10	0.058	36.3 x 76 x 24.5	4954183 151492	×

T-15 Keyhole Saw



A small portable saw with tucker for general or specific purposes.
Most convenient for electricians and carpenters.
The keyhole saw, which is made from steel, can open holes in existing drywall or wood, as well as cut curved or intricate lines.

Cat.No.	Handle color	Suitable blade	QTY/Box	QTY/ Carton	N.W. (kgs)	G.W. (kgs)	M3	Carton size (Cm) D x W x H	EAN	Stock available in Rotterdam
T-15	Yellow	HSB-Z and HSB-W	10	100	8	10	0.058	36.3 x 76 x 24.5	4954183 151508	×

Cutters

HOOK BLADE SERIES

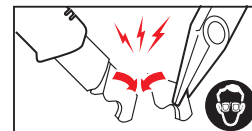
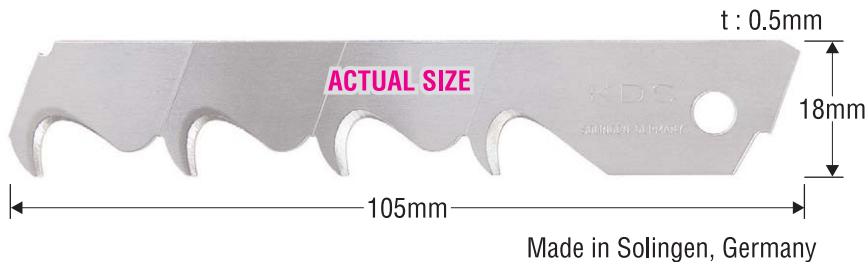

HK-11 Twist L-Hook



Hook it! Slices through materials without damaging the surface. Use it for flooring and roofing, to cut strapping and boxes.

Supplied with 1 Hook Blade from Solingen, Germany.

Cat.No.	Handle color	Suitable blade	QTY/Box	QTY/Carton	N.W.(kgs)	G.W.(kgs)	M3	Carton size (Cm) D x W x H	EAN	Stock available in Rotterdam
HK-11	Yellow	HK-5 EVO	10	100	8	10	0.068	36.3 x 76 x 24.5	4954183 507787	○

HK-12 MultiPro Hook it



With the tucker is great for carpet, it can also be used for prying off lids, tightening screws, and scoring and cutting cardboard.

The knife is loaded with a snap hook blade for cutting surface materials without damaging what is underneath.

Supplied with 1 Hook Blade from Solingen, Germany.

Cat.No.	Handle color	Suitable blade	QTY/Box	QTY/Carton	N.W.(kgs)	G.W.(kgs)	M3	Carton size (Cm) D x W x H	EAN	Stock available in Rotterdam
HK-12	Yellow	HK-5 EVO	10	100	8	10	0.068	36.3 x 76 x 24.5	4954183 512323	×



Cutters

SA-11S Safety Master

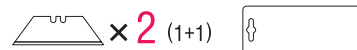

Ergonomically designed safety knife changes the image of the common safety knife!
Rubberized, non-slip grip and lightweight body for comfortable long-term use.

One blade loaded and one spare in the handle.



Anti-lock, recessed slider



One push open for blade change

Cat.No.	Handle color	Suitable blade	QTY/Box	QTY/Carton	N.W.(kgs)	G.W.(kgs)	M3	Carton size (Cm) D x W x H	EAN	Stock available in Rotterdam
SA-11S	Yellow	TB-10C	10	100	10	12	0.056	36.3 x 76 x 24.5	4954183 539948	×

SA-12D Safety Metal

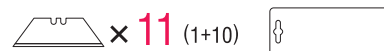

Aluminum die-cast body Safety cutter.
Ergonomics design grip perfectly fits your palm.
Suit for both Right and Left-handers.

Comes with 10 spare blades.

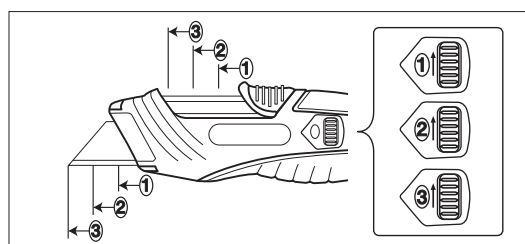









Cat.No.	Handle color	Suitable blade	QTY/Box	QTY/Carton	N.W.(kgs)	G.W.(kgs)	M3	Carton size (Cm) D x W x H	EAN	Stock available in Rotterdam
SA-12D	Metallic Silver	TB-10C	6	36	8	10	0.023	34.5 x 26.5 x 25	4954183 527525	○

Cutter packaging-1

Cat.No.	QTY/Box		QTY/Carton		
Package-Deals					
LC-405 5H	20		80		
L-18 5H					
L-19 5H					
H-12YE-3B			18		
S-20	24		120		
25mm					
H-11YE	10		100		
H-11RE					
H-12YE					
H-12RE					
H-13					
G-18mm					
G-11YE	10				
G-14					
G-15					
G-16					
GC-401	20		200		
18mm					
LC-405	10		100		
L-11YE					
L-11RE					
L-11B					
L-15YE					
L-15RE					
L-17YE					
L-17RE					
L-18EL RE					60
L-18EL BL					
L-18YE			100		
L-18RE					
L-18YEB					
L-18B					
L-19YE					
L-19RE					
L-19YEB					
L-19B					
L-18SS					
L-21YE					
L-21RE					
L-22					
L-23					
L-24					
L-25					
L-30					

Cutter packaging-2

Cat.No.	QTY/Box		QTY/Carton	
9mm				
S-11	10		200	
S-12				
S-13BL				
S-13GR				
S-14YE				
S-14BL				
S-14GR				
S-14YEB				
S-14YE NB				
S-14BL NB				
S-18				
Others				
D-12BL	5		100	
D-12YE				
D-12GR				
P-11YE				
P-11RE				
T-11	10		100	
T-14				
T-15				
HK-11				
HK-12				
SA-11S	6		36	
SA-12D				
RT-45				
RT-45	12		96	
RTB-45	50		300	

Safety-Bases

Safety-Bases e

Concern for our planet
 Non-toxic if incinerated.
 Made of Olefin resin.

From easy-to-use day-timer size to large desk size, choose the one that's best for you.

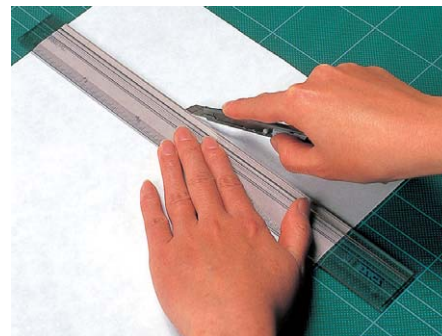
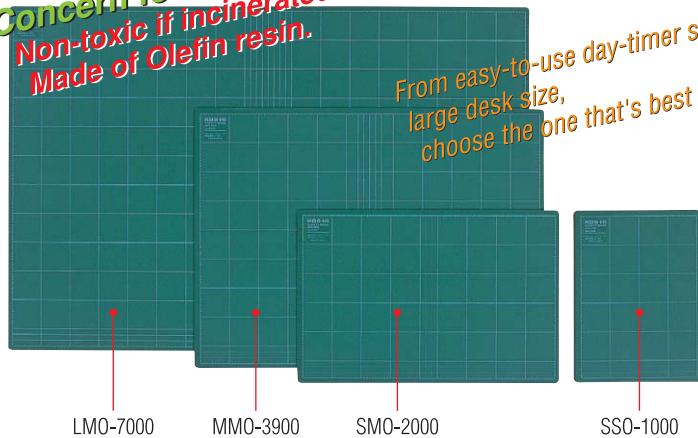

Takes an edge softly, keeps the media from slipping, protects your desk or table from scratches, and makes cutting safe.

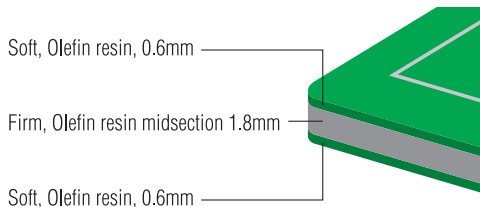

Three environmental-E!!

Use both sides! Lasts twice as long!
 Made of Olefin resin. Rigid and lightweight.
 Efficient, 5mm grid lines.

Cat.No.	Size(mm)	QTY/Box	QTY/Carton	N.W.(kgs)	G.W.(kgs)	M3	Stock available in Rotterdam
Easy-eye Green							
SSO-1000	300 x 220 x 3	10	80	24	26	0.045	×
SMO-2000	450 x 300 x 3		40				
MMO-3900	620 x 450 x 3		20	23	25		
LMO-7000	600 x 900 x 3		10				

Safety-Bases

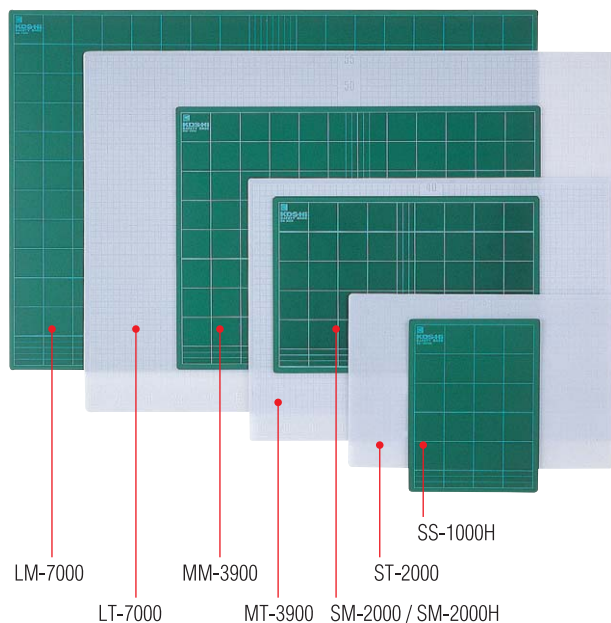

Layered construction

Soft type

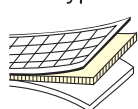

Soft PVC 1.0mm
 Hard PVC 1.0mm
 Soft PVC 1.0mm
 Thickness 3.0mm

Hard type

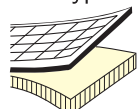

Soft PVC 1.0mm
 Hard PVC 2.0mm
 Thickness 3.0mm

No matter how many times it's cut, slices don't stand-out or expand.
 One-coat adhesive tapes (double-sided tape, etc.) come up easily.
 Use both sides : soft on front and back (no grid lines on back)
 The translucent mat is perfect for safe tracing and cutting on light tables.
 When stored flat, the layered construction of the Safety Base resists bending, warping, delaminating, or cracking.

Cat.No.	TYPE	Size(mm)	QTY/Box	QTY/Carton	N.W.(kgs)	G.W.(kgs)	M3	Stock available in Rotterdam
Easy-eye Green								
SS-1000H	Hard type	300 x 220 x 3	10	80	24	26	0.045	×
SM-2000H		450 x 300 x 3						40
SM-2000	Soft type	450 x 300 x 3		20	23	25		×
MM-3900		620 x 450 x 3						×
LM-7000		900 x 620 x 3	10	0.045	×			
CM-80x120G	800 x 1200 x 3	22			24	×		
CM-100x150G		1000 x 1500 x 3	5	5	25	27	0.030	×
Translucent								
ST-2000	Soft type	450 x 300 x 3	10	40	23	25	0.045	×
MT-3900		620 x 450 x 3		20			0.085	×
LT-7000		900 x 620 x 3		10			0.045	×

Spare Blades

Hard but Pliable

KDS black blades have undergone the ideal heat treatment for cutter blades.

Made in Japan

The **Blade** is the heart of the knife.

KDS provides first class blades with over 40 years of know-how and strict quality control systems.



Press



Heat Treatment



Edging



Control board



Surface Inspecting



Cutting Test



KDS® Evolution

An Evolution in Knife Blades
KDS introduces the world's finest blades!



SHARP EDGE

Designed for Maximum Sharpness



DURABLE EDGE

Designed for Maximum Durability

Why are EVO blades better?

Quality Steel



Only the best steel for the best blades!

Tempering



Tempered for the optimum balance of hardness and pliability.

Honing Angles

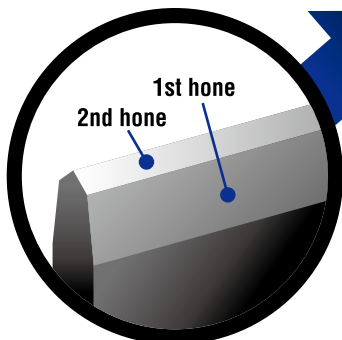

Double-honed, ideal for the job.

Grinding

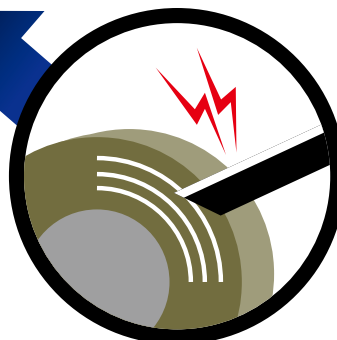

Ground for a smooth, clean cut.



Paper cutting test

Purpose : To test Blade Sharpness and Durability

750g of weight is loaded on the blade, and the full blade is pulled through a stack of newsprint that is 7.5mm wide. After each pass, the number of cut sheets is measured. The test is repeated 32 times per blade.

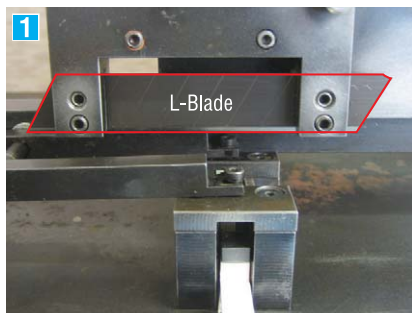

Step 1 : Setting up a blade

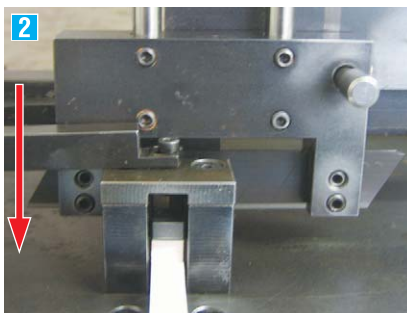

Step 2 : Cutting the paper with 750g weight

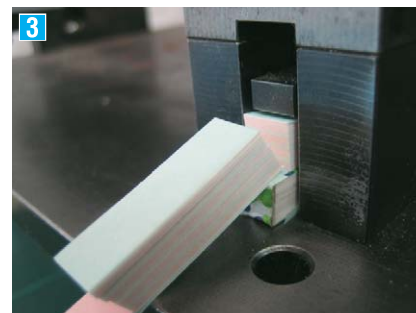

Step 3 : Measuring the cut sheets

TEST RESULT **Based on our internal test** Number of sheets cut and number of passes made

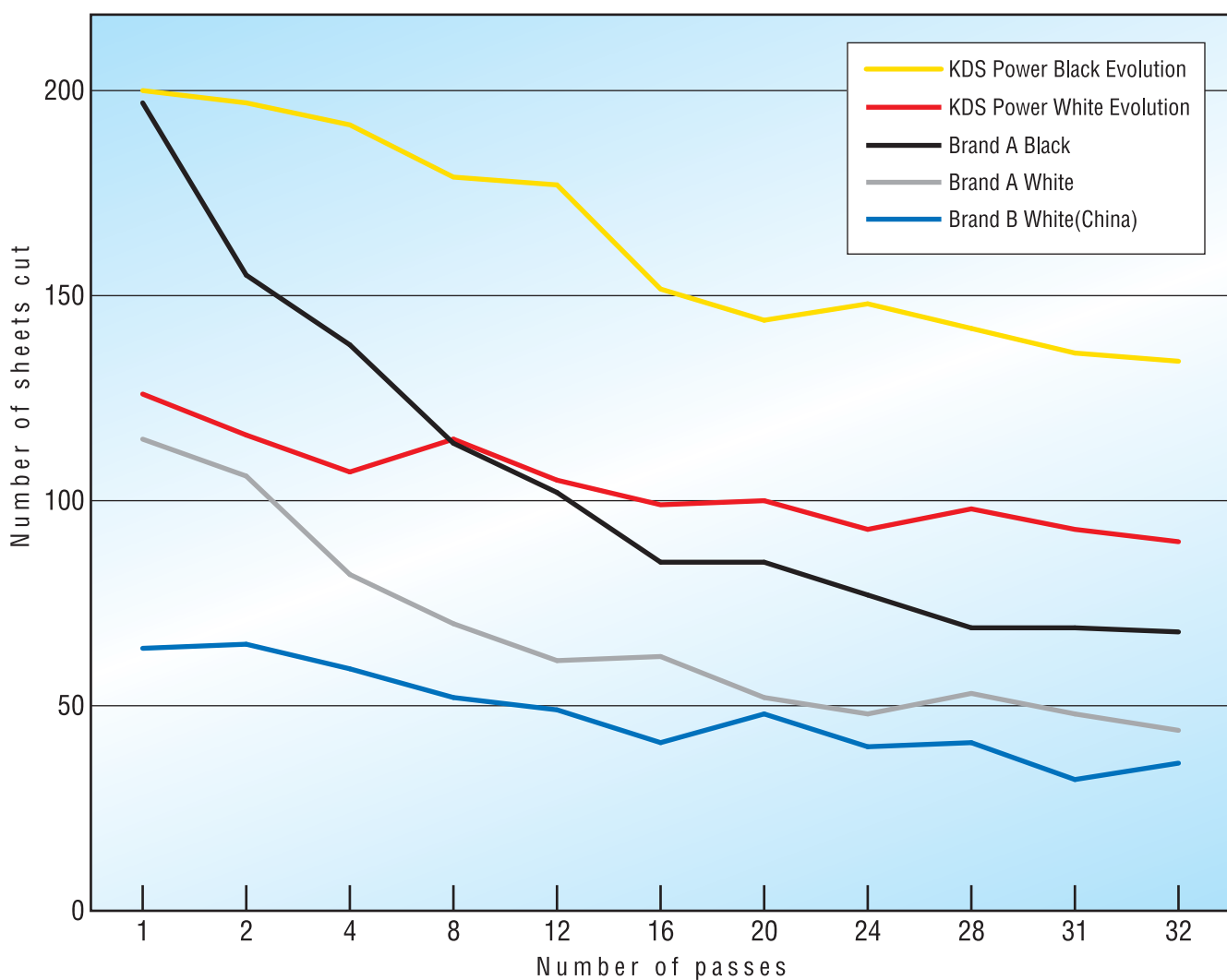

Choose the blade that's right for the job!

Spare Blades Packaging

Display box



9
mm

S-Blades

SB-10B EVO
SB-10 EVO
SB-10BNL EVO
SB-10NL EVO
SB-10S EVO
VB-10 EVO

SB-50B EVO
SB-50 EVO
SB-50BNL EVO
SB-50NL EVO
SB-50S EVO
SB-50S EVO-S

G-18
mm

G-Blades

GB-10B EVO
GB-10 EVO
GB-10W EVO

18
mm

L-Blades

LB-10B EVO
LB-10 EVO
LB-10BW EVO
LB-10W EVO
LB-10BNL EVO
LB-10NL EVO
LB-5S EVO
HK-5 EVO

GB-50B EVO
GB-50 EVO
GB-50W EVO

LB-50B EVO
LB-50 EVO
LB-50BNL EVO
LB-50NL EVO

Plain box

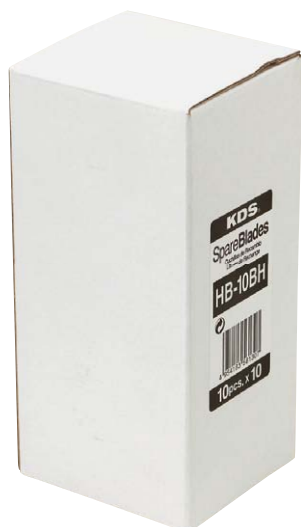

25
mm

H-Blades

HB-5B EVO
HB-10B EVO
HB-10 EVO
HB-10BNL EVO
HB-10NL EVO

G-18
mm

G-Blades

GP-6

18
mm

L-Blades

LP-32

Others

TB-10C
HSB-W
HSB-Z

PB-10
PB-10A
DB-45

Spare Blades

25 mm

Extra Heavy Duty blades

H-Blades

H-Blades are 40% thicker than standard L-Blades.
Recommended for cutting tough materials like plaster board.

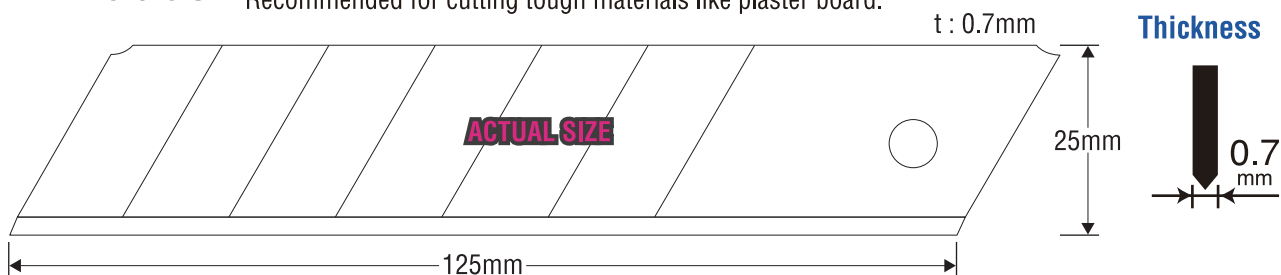

Application : for all H-type cutters H-11 H-12 H-12YE-3B H-13



G-18 mm

Heavy Duty PRO blades

G-Blades

G-Blades are 20% thicker than standard L-Blades and suit for more solid job.
Other dimensions are same as L-Blades.

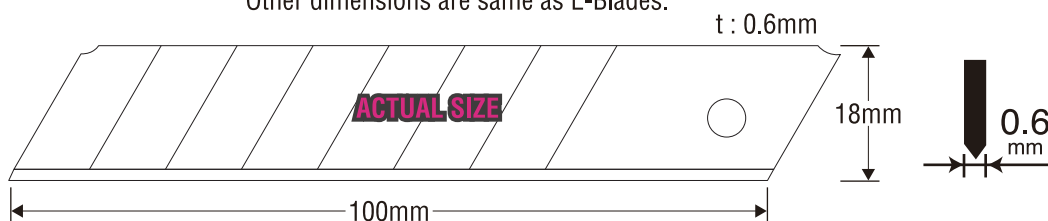

Application : for all G-type cutters and GG scrapers (SCL-200 SCL-300 and SCL-600)



18 mm

Heavy Duty blades

L-Blades

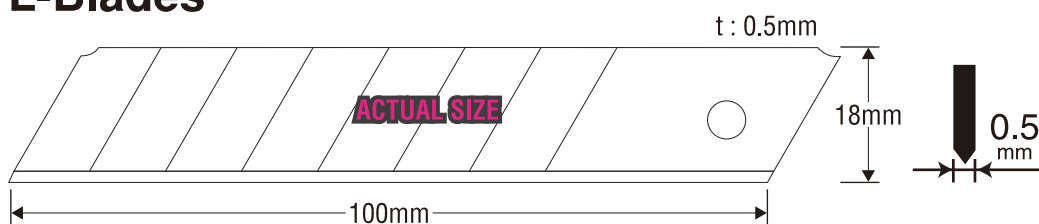

Application : for all L-type cutters and GG scrapers (SCL-200 SCL-300 and SCL-600)



9 mm

Standard Duty blades

S-Blades

S-Blade is most popular standard cutter for general cutting.

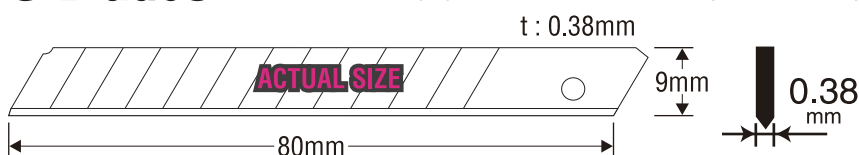

Application : for S-11 S-12 S-13 S-14 S-20



Spare Blades

H-Blades 25 mm

EVO SHARP EDGE

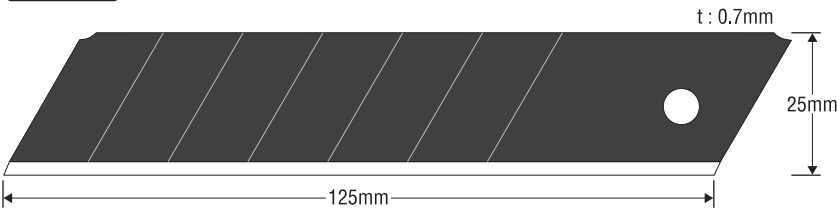

Cat.No.	Number of blades in a case	QTY/Box	QTY/Carton	N.W. (kgs)	G.W. (kgs)	M3	Carton size (Cm) D x W x H	EAN	Stock available in Rotterdam
HB-5B EVO	5	10	100	10	12	0.006	17 x 19 x 18.5	4954183 524784	×
HB-10B EVO	10			20	22			4954183 524791	○

EVO DURABLE EDGE

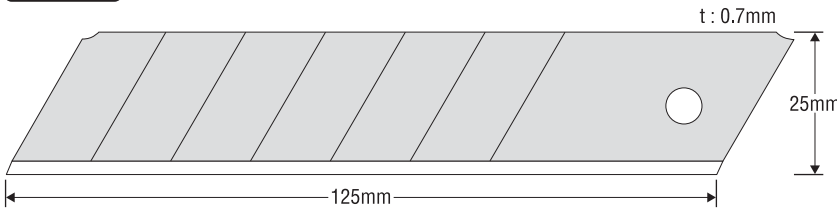

Cat.No.	Number of blades in a case	QTY/Box	QTY/Carton	N.W. (kgs)	G.W. (kgs)	M3	Carton size (Cm) D x W x H	EAN	Stock available in Rotterdam
HB-10 EVO	10	10	100	20	22	0.006	17 x 19 x 18.5	4954183 524807	○

Non-Snap Series Solid blades, non-snap blades for special purpose

EVO SHARP EDGE

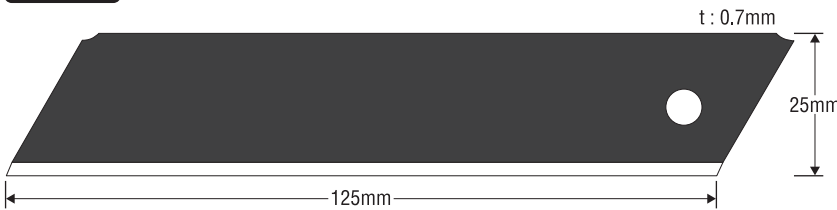

Cat.No.	Number of blades in a case	QTY/Box	QTY/Carton	N.W. (kgs)	G.W. (kgs)	M3	Carton size (Cm) D x W x H	EAN	Stock available in Rotterdam
HB-10BNL EVO	10	10	100	20	22	0.006	17 x 19 x 18.5	4954183 524814	×

EVO DURABLE EDGE

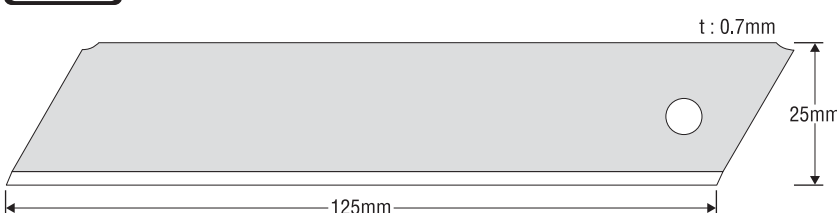

Cat.No.	Number of blades in a case	QTY/Box	QTY/Carton	N.W. (kgs)	G.W. (kgs)	M3	Carton size (Cm) D x W x H	EAN	Stock available in Rotterdam
HB-10NL EVO	10	10	100	20	22	0.006	17 x 19 x 18.5	4954183 524821	×

Spare Blades

G-Blades G-18 mm

EVO SHARP EDGE

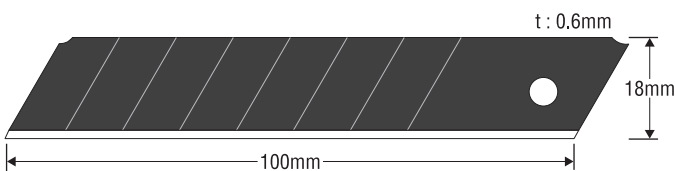

Cat.No.	Number of blades in a case	QTY/Box	QTY/Carton	N.W. (kgs)	G.W. (kgs)	M3	Carton size (Cm) D x W x H	EAN	Stock available in Rotterdam
GB-10B EVO	10	20	200	19	21	0.014	24 x 36 x 15.5	4954183 524715	○
GB-50B EVO	50	10	50	21	23	0.011	15 x 45 x 16.5	4954183 524722	×

EVO DURABLE EDGE

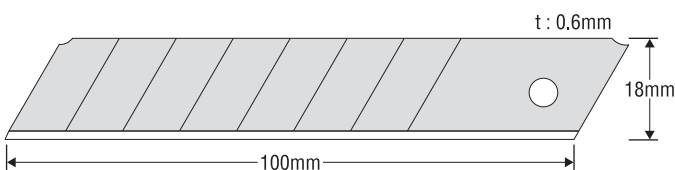

Cat.No.	Number of blades in a case	QTY/Box	QTY/Carton	N.W. (kgs)	G.W. (kgs)	M3	Carton size (Cm) D x W x H	EAN	Stock available in Rotterdam
GB-10 EVO	10	20	200	19	21	0.014	24 x 36 x 15.5	4954183 524739	○
GB-50 EVO	50	10	50	21	23	0.011	15 x 45 x 16.5	4954183 524746	○
GP-6 EVO	6(1 safety-pack)	20	200	11	13	0.014	24 x 36 x 15.5	4954183 529215	×

15 segments Blades

EVO DURABLE EDGE

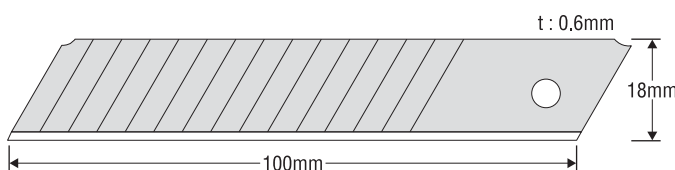

Cat.No.	Number of blades in a case	QTY/Box	QTY/Carton	N.W. (kgs)	G.W. (kgs)	M3	Carton size (Cm) D x W x H	EAN	Stock available in Rotterdam
GB-10W EVO	10	20	200	19	21	0.014	24 x 36 x 15.5	4954183 524753	○
GB-50W EVO	50	10	50	21	23	0.011	15 x 45 x 16.5	4954183 524760	×

Spare Blades

L-Blades 18mm

EVO SHARP EDGE

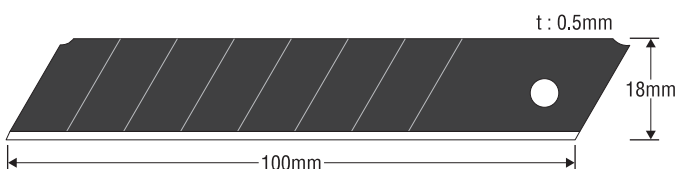

Cat.No.	Number of blades in a case	QTY/Box	QTY/Carton	N.W. (kgs)	G.W. (kgs)	M3	Carton size (Cm) D x W x H	EAN	Stock available in Rotterdam
LB-10B EVO	10	20	200	15	17	0.014	24 x 36 x 15.5	4954183 528409	○
LB-50B EVO	50	10	50	19	21	0.011	15 x 45 x 16.5	4954183 528416	○

EVO DURABLE EDGE

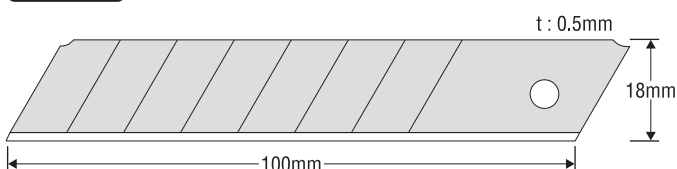

Cat.No.	Number of blades in a case	QTY/Box	QTY/Carton	N.W. (kgs)	G.W. (kgs)	M3	Carton size (Cm) D x W x H	EAN	Stock available in Rotterdam
LB-10 EVO	10	20	200	15	17	0.014	24 x 36 x 15.5	4954183 528423	○
LB-50 EVO	50	10	50	19	21	0.011	15 x 45 x 16.5	4954183 528430	○
LP-32	32(4 safety-pack)	5	50	13	15	0.012	24 x 29.3 x 16	4954183 507022	×

15 segments Blades

EVO SHARP EDGE

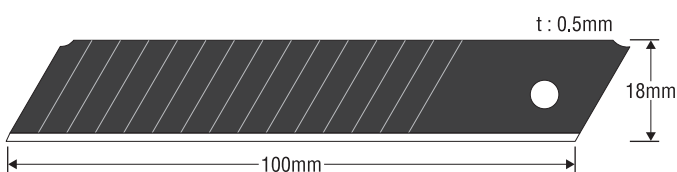

Cat.No.	Number of blades in a case	QTY/Box	QTY/Carton	N.W. (kgs)	G.W. (kgs)	M3	Carton size (Cm) D x W x H	EAN	Stock available in Rotterdam
LB-10BW EVO	10	20	200	15	17	0.014	24 x 36 x 15.5	4954183 528294	×

EVO DURABLE EDGE

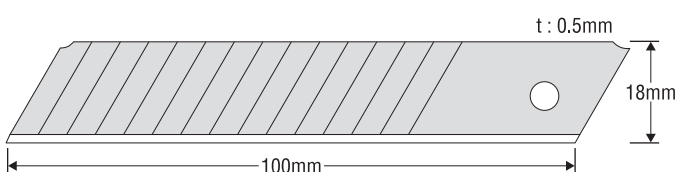

Cat.No.	Number of blades in a case	QTY/Box	QTY/Carton	N.W. (kgs)	G.W. (kgs)	M3	Carton size (Cm) D x W x H	EAN	Stock available in Rotterdam
LB-10W EVO	10	20	200	15	17	0.014	24 x 36 x 15.5	4954183 528287	○

Spare Blades

L-Blades 18mm

Non-Snap Blades

Solid blades, non-snap blades for special purpose

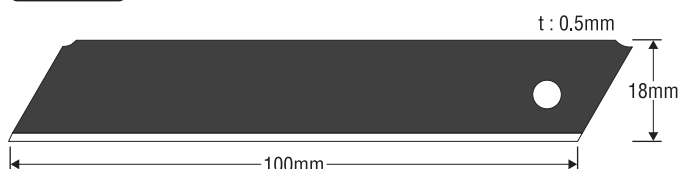

Cat.No.	Number of blades in a case	QTY/Box	QTY/Carton	N.W. (kgs)	G.W. (kgs)	M3	Carton size (Cm) D x W x H	EAN	Stock available in Rotterdam
LB-10BNL EVO	10	20	200	15	17	0.014	24 x 36 x 15.5	4954183 524678	○
LB-50BNL EVO	50	10	50	19	21	0.011	15 x 45 x 16.5	4954183 524685	×

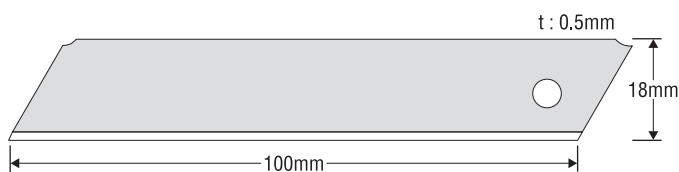

Cat.No.	Number of blades in a case	QTY/Box	QTY/Carton	N.W. (kgs)	G.W. (kgs)	M3	Carton size (Cm) D x W x H	EAN	Stock available in Rotterdam
LB-10NL EVO	10	20	200	15	17	0.014	24 x 36 x 15.5	4954183 524692	×
LB-50NL EVO	50	10	50	19	21	0.011	15 x 45 x 16.5	4954183 524708	×

Stainless steel Series Perfect for wet environments

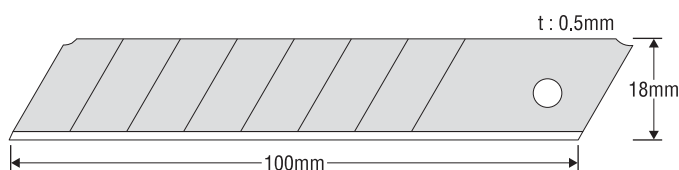

LB-5S EVO



Stainless steel blade

Cat.No.	Number of blades in a case	QTY/Box	QTY/Carton	N.W. (kgs)	G.W. (kgs)	M3	Carton size (Cm) D x W x H	EAN	Stock available in Rotterdam
LB-5S EVO	5	20	200	9	11	0.014	24 x 36 x 15.5	4954183 528836	×

Spare Blades

S-Blades 9mm

EVO SHARP EDGE

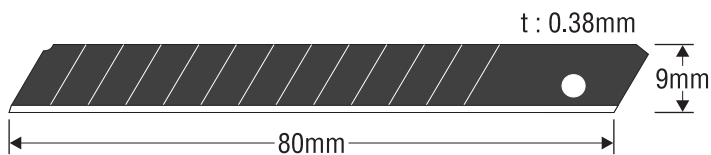

Cat.No.	Number of blades in a case	QTY/Box	QTY/Carton	N.W. (kgs)	G.W. (kgs)	M3	Carton size (Cm) D x W x H	EAN	Stock available in Rotterdam
SB-10B EVO	10	20	200	5	7	0.007	16 x 31 x 14	4954183 524838	○
SB-50B EVO	50	10	50	18	20	0.004	9 x 33.5 x 13	4954183 524845	×

EVO DURABLE EDGE

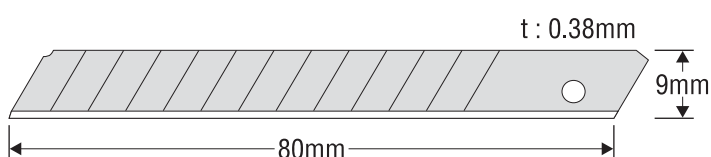

Cat.No.	Number of blades in a case	QTY/Box	QTY/Carton	N.W. (kgs)	G.W. (kgs)	M3	Carton size (Cm) D x W x H	EAN	Stock available in Rotterdam
SB-10 EVO	10	20	200	5	7	0.007	16 x 31 x 14	4954183 524852	○
SB-50 EVO	50	10	50	18	20	0.004	9 x 33.5 x 13	4954183 524869	×

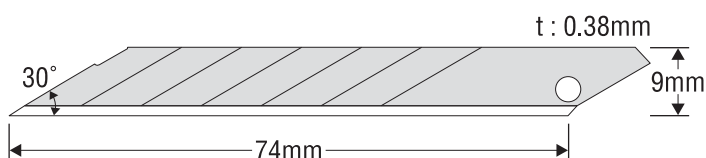

Application : S-18

Cat.No.	Number of blades in a case	QTY/Box	QTY/Carton	N.W. (kgs)	G.W. (kgs)	M3	Carton size (Cm) D x W x H	EAN	Stock available in Rotterdam
VB-10 EVO	10	20	200	7	9	0.007	16 x 31 x 14	4954183 528478	○

Stainless steel Series Perfect for wet environments

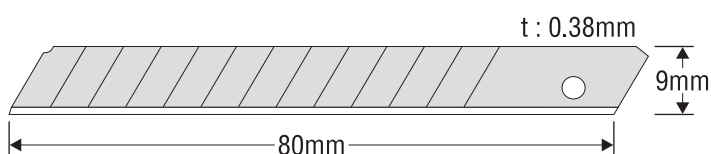

Application : S-11

Cat.No.	Number of blades in a case	QTY/Box	QTY/Carton	N.W. (kgs)	G.W. (kgs)	M3	Carton size (Cm) D x W x H	EAN	Stock available in Rotterdam
SB-10S EVO	10	20	200	5	7	0.007	16 x 31 x 14	4954183 528812	○
SB-50S EVO	50	10	50	18	20	0.004	9 x 33.5 x 13	4954183 528829	×
SB-50S EVO-S								4954183 530075	

Spare Blades

S-Blades 9mm

Non-Snap Blades Solid blades, non-snap blades for special purpose



Cat.No.	Number of blades in a case	QTY/Box	QTY/Carton	N.W. (kgs)	G.W. (kgs)	M3	Carton size (Cm) D x W x H	EAN	Stock available in Rotterdam
SB-10BNL EVO	10	20	200	5	7	0.007	16 x 31 x 14	4954183 528300	○
SB-50BNL EVO	50	10	50	18	20	0.004	9 x 33.5 x 13	4954183 528317	×



Cat.No.	Number of blades in a case	QTY/Box	QTY/Carton	N.W. (kgs)	G.W. (kgs)	M3	Carton size (Cm) D x W x H	EAN	Stock available in Rotterdam
SB-10NL EVO	10	20	200	5	7	0.007	16 x 31 x 14	4954183 528485	×
SB-50NL EVO	50	10	50	18	20	0.004	9 x 33.5 x 13	4954183 530129	×

Saws

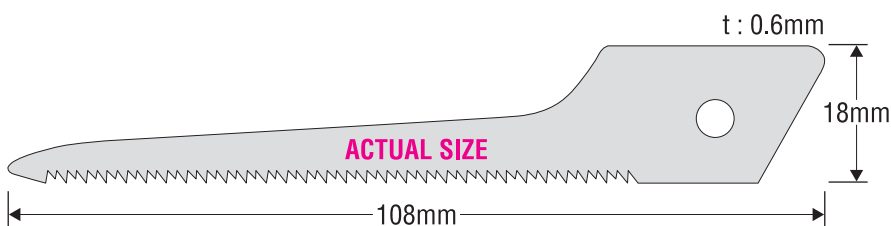

Application : T-11 T-14 T-15

Cat.No.	Number of blades in a case	QTY/Box	QTY/Carton	N.W. (kgs)	G.W. (kgs)	M3	Carton size (Cm) D x W x H	EAN	Stock available in Rotterdam
HSB-W	1	10	100	3	4	0.022	33 x 36 x 18.5	4954183 516826	×

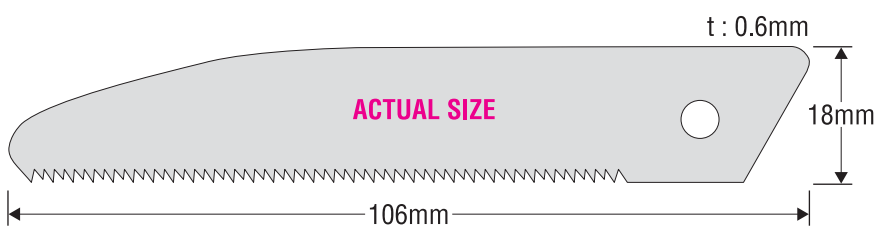

Application : T-11 T-14 T-15

Cat.No.	Number of blades in a case	QTY/Box	QTY/Carton	N.W. (kgs)	G.W. (kgs)	M3	Carton size (Cm) D x W x H	EAN	Stock available in Rotterdam
HSB-Z	1	10	100	3	4	0.022	33 x 36 x 18.5	4954183 516819	×

KDS® The Pro's Quality Choice

Power Black Evolution



1 HB-5B EVO 2 HB-10B EVO 6 GB-10B EVO 10 GB-50B EVO



12 LB-10B EVO 20 LB-50B EVO 24 SB-10B EVO 30 SB-50B EVO

Power White Evolution



3 HB-10 EVO 7 GB-10 EVO 11 GB-50 EVO 13 LB-10 EVO



21 LB-50 EVO 25 SB-10 EVO 31 SB-50 EVO 26 VB-10 EVO

Non-Snap series

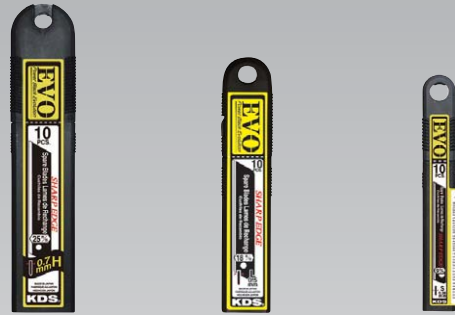

4 HB-10BNL EVO 16 LB-10BNL EVO 28 SB-10BNL EVO



5 HB-10NL EVO 17 LB-10NL EVO 29 SB-10NL EVO

15 segments series



9 GB-10W EVO 14 LB-10BW EVO 15 LB-10W EVO

Stainless steel series



18 LB-5S EVO 27 SB-10S EVO 32 SB-50S EVO 33 SB-50S EVO-S

Trapezoidal series



38 TB-10C

Others



19 HK-5 EVO



36 HSB-W



37 HSB-Z

























40 DB-48



41 PB-10

Spare Blades packaging

No.	Cat.No.	Number of blades in a case	QTY/Box		QTY/Carton				
25mm									
1	HB-5B EVO	5	10		100				
2	HB-10B EVO	10							
3	HB-10 EVO								
4	HB-10BNL EVO								
5	HB-10NL EVO								
G-18mm									
6	GB-10B EVO	10	20		200				
7	GB-10 EVO								
8	GP-6 EVO								
9	GB-10W EVO								
10	GB-50B EVO	50	10		50				
11	GB-50 EVO								
18mm									
12	LB-10B EVO	10	20		200				
13	LB-10 EVO								
14	LB-10BW EVO								
15	LB-10W EVO								
16	LB-10BNL EVO								
17	LB-10NL EVO	5	5		50				
18	LB-5S EVO								
19	HK-5 EVO	50	10		50				
20	LB-50B EVO								
21	LB-50 EVO								
22	LB-50BNL EVO								
23	LB-50NL EVO	10	20		200				
24	SB-10B EVO								
25	SB-10 EVO								
26	VB-10 EVO								
27	SB-10S EVO								
28	SB-10BNL EVO								
29	SB-10NL EVO	50	10		50				
30	SB-50B EVO								
31	SB-50 EVO								
32	SB-50S EVO								
33	SB-50S EVO-S								
34	SB-50BNL EVO								
35	SB-50NL EVO	Saws							
36	HSB-W	1	10		100				
37	HSB-Z								
Trapezoidal series									
38	TB-10C	10	10		50				
Others									
39	LP-32	32	5						
40	DB-48	48	10		100				
41	PB-10	10							
42	PB-10A								

GG Scraper

KDS



Recommended for removal of various materials, including wallpaper and tile, paint, gaskets, adhesives, and floor coverings.

- 1) Fluoroplastic-coated head prevents sticking and allows for easy cleaning.
- 2) No need for screwdrivers or coins, the thumb-locking screws keep the blade tight.
- 3) Three length to suit the specific job.



Come with 5 non-snap blades

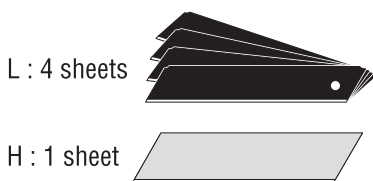

The H-type blades is 40% thicker and 38% wider than L-type blades for heavy duty task.

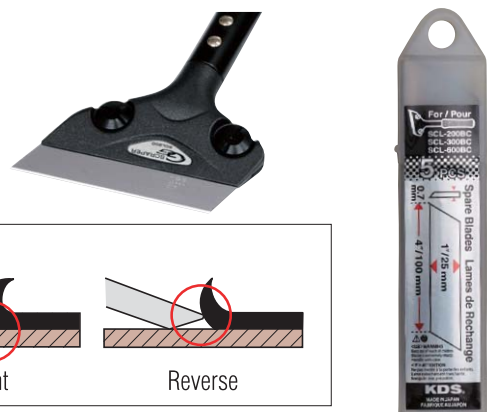
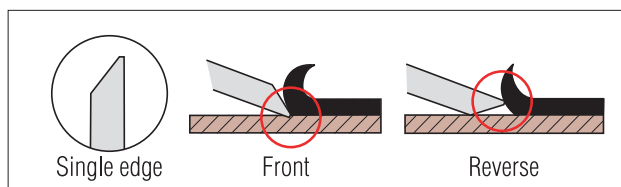
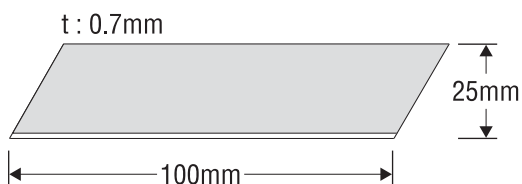

* H-type is dedicated blades for GG Scraper series.

HB-5SCL

Cat. No.	Description	Size	QTY/Box	QTY/Carton	N.W. (kgs)	G.W. (kgs)	M3	Carton size (Cm) D x W x H	EAN	Stock available in Rotterdam
SCL-200BC	Come with a BLADE COVER and 5 non-snap blades	200mm	4	24	10	12	0.058	56 x 34 x 30	4954183 525538	○
SCL-300BC		300mm			13	15	0.070	56 x 43 x 30	4954183 525545	○
SCL-600BC		600mm			0.124	74 x 57 x 30	4954183 525552	○		
LB-10BNL EVO	10 blades in a pla. case	L-type (t:0.5mm)	20	200	15	17	0.014	24 x 36 x 15.5	4954183 524678	○
HB-5SCL	5 blades in a pla. case	H-type (t:0.7mm)							4954183 528133	×

Stainless steel putty knives



Co-mold non-slip rubber grip and 4 screw bits in the handle.
Hardened and tempered stainless steel blade.

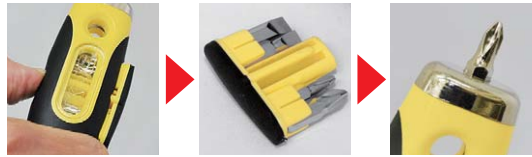

⊕ #1, #2
⊖ 1/4", 3/16"

Flexible type



Chisel type



14-in-1 type

SC-M76SD:
 1 : Scraping
 2 : Spreading
 3 : Opening paint cans
 4 : Cleaning out cracks
 5 : Pulling nails
 6 : Cleaning paint rollers
 7 : Scraping convex
 8 : Opening bottle caps
 9 : Scraping concave
 10 : Setting nails
 11-14: Screw drivers
 ⊕ : #1, #2 ⊖ : 1/4", 3/16"

122mm
 Foldable !!

Removing paint from pipe

Pulling Nail

	Cat.No.	Type	Width	QTY/Box	QTY/ Carton	N.W. (kgs)	G.W. (kgs)	M3	Carton size (Cm) D x W x H	EAN	Stock available in Rotterdam				
①	SC-F38SD	Flexible	1-1/2" / 38mm	12	72	9	11	0.034	27 x 59 x 21	4954183 525156	×				
②	SC-F51SD		2" / 51mm			10	12			4954183 525163	×				
③	SC-F76SD		3" / 76mm			11	13			4954183 525170	×				
④	SC-F102SD		4" / 102mm			12	14			4954183 525187	×				
⑤	SC-F127SD		5" / 127mm			10	12			4954183 525194	×				
⑥	SC-F152SD		6" / 152mm			11	13			4954183 525200	×				
⑦	SC-C38SD	Chisel	1-1/2" / 38mm		12	72	10	12	0.034	27 x 59 x 21	4954183 525132	×			
⑧	SC-C51SD		2" / 51mm				11	13			-	×			
⑨	SC-C76SD		3" / 76mm				11	13			4954183 530181	×			
⑩	SC-M76SD	Chisel 14-in-1	3" / 76mm				144	17			22	0.065	37 x 76 x 25	4954183 530174	×
⑪	SC-M35	Fold out 14-in-1	1-1/2" / 38mm											4954183 525149	×

Cutters

BK-10 Banana sickle



The Banana Sickie is recommended for multi-purpose use, i.e. for flooring, agriculture, roofing, etc, etc. High carbon steel blade. Yellow painted wooden handle.



Cat.No.	Color	Handle Length	QTY/Box	QTY/Carton	N.W. (kgs)	G.W. (kgs)	M3	"Carton size (cm) D x W x H"	EAN	Stock available in Rotterdam
BK-10	Yellow	120mm	6	144	14	16	0.062	30 x 64 x 32	4954183 525057	×

Scissors

Stainless Steel Scissors



KSC-1

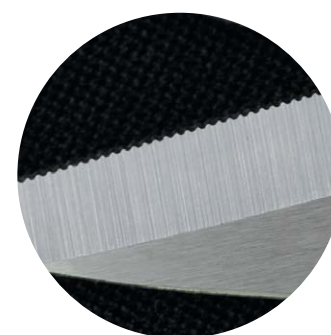

Recommended for professionals as well as DIY users. Stainless steel blades and secure hinge for heavy-duty tasks. Non-slip serrated blades assure safe and smooth cutting.



KSC-2



Carton



Box

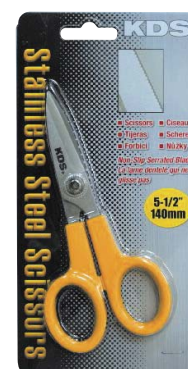

KSC-1

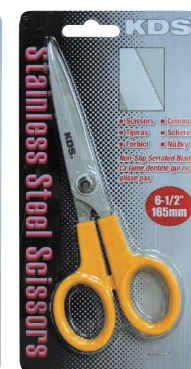

KSC-2

Cat.No.	Color	Size	QTY/Box	QTY/Carton	N.W. (kgs)	G.W. (kgs)	M3	"Carton size (cm) D x W x H"	EAN	Stock available in Rotterdam
KSC-1	Yellow	5-1/2" 140mm	12	96	7	9	0.027	26 x 43 x 24	4954183 561901	○
KSC-2		6-1/2" 165mm			8	10			4954183 527761	○

CLAMPS

Metal Handy clamp



Aluminum pressure adjusting power clamp. Cushioned jaw heads with auto bounce-back action when tightened.

Cat.No.	Capacity	QTY/Box	QTY/ Carton	N.W. (kgs)	G.W. (kgs)	M3	"Carton size (cm) D x W x H"	EAN	Stock available in Rotterdam
MHC-76	75mm	12	48	15	17	0.051	32 x 44 x 36	-	×



Metal Bar Clamp



Bar Clamp & Spreader with aluminum alloy body and steel, forged parts. Buffered jaw head with auto bounce-back action when tightened.

Carbon steel bar.

Jaw depth of 85mm with pads.

Quick release trigger on the handle. Clamping force up to 350kg / 770lbs

Cat.No.	Capacity	QTY/Box	QTY/ Carton	N.W. (kgs)	G.W. (kgs)	M3	"Carton size (cm) D x W x H"	EAN	Stock available in Rotterdam	
MBC-150	150mm	6	12	11	13	0.026	39 x 26 x 26	4954183 539429	×	
MBC-300	300mm			12	14	0.037	54 x 26 x 26	4954183 539436	×	
MBC-450	450mm			6	14	16	0.020	68 x 24 x 12	4954183 539450	×
MBC-600	600mm				15	17	0.024	83 x 24 x 12	4954183 539481	×
MBC-1200	1200mm	4	12	20	22	0.105	150 x 26 x 27	4954183 539498	×	



Metal Hold Down Clamp



Hold Down Clamp & Vise with aluminum alloy body and steel forging parts.

Carbon steel bar.

Jaw depth of 85mm with pads.

Lever handle for easy release.

Clamping force up to 300kg / 660lbs



MF-01

Cat.No.	Capacity	QTY/Box	QTY/ Carton	N.W. (kgs)	G.W. (kgs)	M3	"Carton size (cm) D x W x H"	EAN	Stock available in Rotterdam
MWB-150	150mm	6	12	11	13	0.020	45 x 28 x 16	4954183 539511	×
MWB-300	300mm			13	15	0.027	60 x 28 x 16	4954183 539528	×
MWB-450	450mm			15	17	0.014	75 x 13 x 14	4954183 539535	×
MWB-600	600mm			17	19	0.016	89 x 13 x 14	4954183 539542	×
MF-01	2 Stands for MWB series	12		2	3	-	-	-	×

Metal pipe clamp



Professional Heavy Duty Pipe Clamp & Spreader with aluminum alloy body and steel, forged parts. Pipe is not part of the product. (fits ϕ 27.2mm, 3/4 inch).

Clamping force up to 1,000kg.



Cat.No.	Description	QTY/Box	QTY/ Carton	N.W. (kgs)	G.W. (kgs)	M3	"Carton size (cm) D x W x H"	EAN	Stock available in Rotterdam
PC-01	Fits ϕ 27.2mm, 3/4 inch	6	12	14	16	0.039	29 x 51 x 26	-	×
FP-01	Stands for PC-01	12		3	4	-	-	-	×



Pocket Tapes



News paper advertisement in 1936



Escargots

Go Retro! Go back in KDS history to 1936 when we imported small pocket tapes from Germany. Renewed with modern technology, the Escargot combines simple functionality with timeless style.

Cat.No.	Length	Width	QTY/Box	QTY/Carton	N.W. (kgs)	G.W. (kgs)	M3	"Carton size (cm) D x W x H"	Stock available in Rotterdam
RSB-2BP	2m	16mm	6	60	4	5	0.024	34 x 49 x 15	×

Coatings



DURA COAT

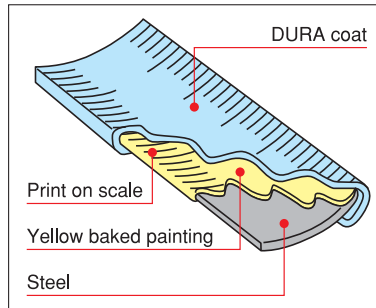

10 times more durable than Acrylic coating but case size as compact as Acrylic.



MAT FINISH Coat

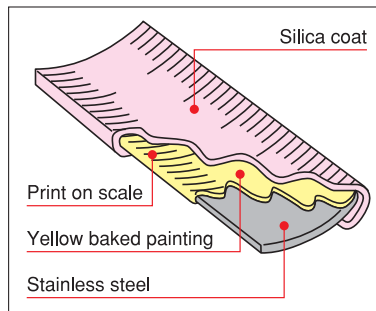

Nylon Coat

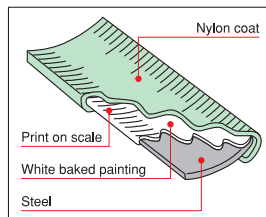

KDS Standard

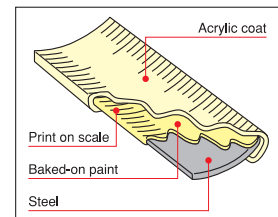

Double-faced scale

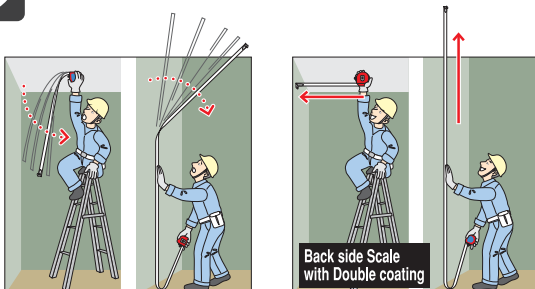

Strong 4rivets

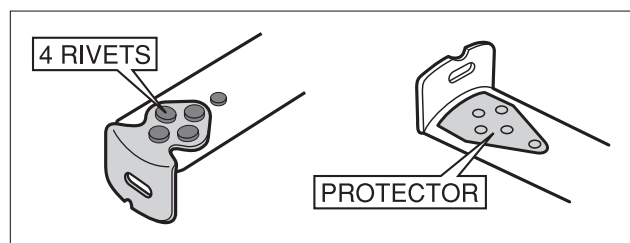

Pocket Tapes Double-faced Scale



New ergonomic design case



Short-Stroke Slider



KDS traditional model



GGEVO

Approx. 12mm

Approx. 6mm

Shortened about 6mm

Nylon coated blade*

5 times more durable than the KDS original acrylic coating

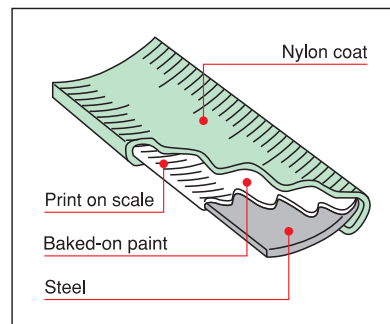

* Except GGEVO25-10 series

New elastomer damper

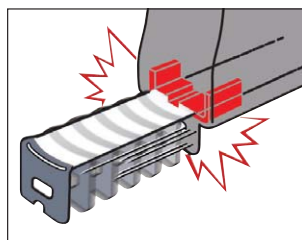

KDS traditional model

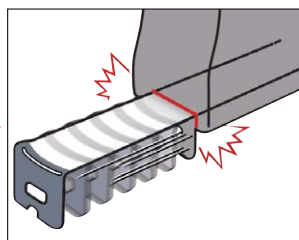

GGEVO

4-Rivet, Diamond-Pattern Tip and protector

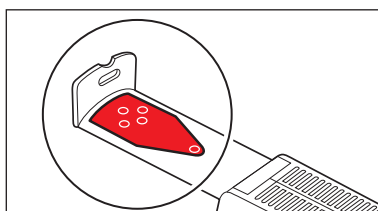
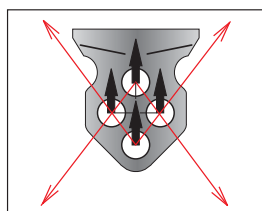

Scales on Front and Back

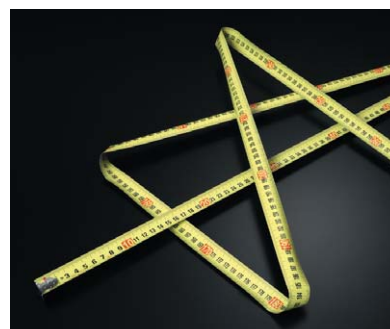

Pocket Tapes Double-faced Scale

GGEVO 19



New ergonomic design case.

The nylon-coated blade is **5 times more durable** than the KDS original acrylic coating.

Non-slip rubberized grip fits your palm and protects the case from damage.

Hook protector protects end-hook.

The tape itself has scales on both sides to easily measure heights, and comes with a strong, 4-rivet diamond-pattern hook.



	Cat.No.	Length	Width	QTY/Box	QTY/Carton	N.W. (kgs)	G.W. (kgs)	M3	"Carton size (cm) D x W x H"	Stock available in Rotterdam
EU	GGEVO19-55EU	5.5m	19mm	4	40	12	14	0.045	22 x 65 x 32	○
ME	GGEVO19-55ME	5.5m x 18ft.								×

*



GGEVO 25



New ergonomic design case.

The nylon-coated blade is **5 times more durable** than the KDS original acrylic coating. *

Non-slip rubberized grip fits your palm and protects the case from damage.

Hook protector protects end-hook.

The tape itself has scales on both sides to easily measure heights, and comes with a strong, 4-rivet diamond-pattern hook.

*Except GGEVO25-10 series.



	Cat.No.	Length	Width	QTY/Box	QTY/Carton	N.W. (kgs)	G.W. (kgs)	M3	"Carton size (cm) D x W x H"	Stock available in Rotterdam		
EU	GGEVO25-55EU	5.5m	25mm	4	40	16	18	0.045	22 x 65 x 32	○		
	GGEVO25-75EU	7.5m				20	22			0.050	24 x 65 x 32	○
	GGEVO25-10EU	10m				24	26					○
ME	GGEVO25-55ME	5.5m x 18ft				16	18	0.045	22 x 65 x 32	×		
	GGEVO25-75ME	7.5m x 25ft				20	22			×		
	GGEVO25-10ME	10m x 33ft				24	26			0.050	24 x 65 x 32	×
E (inch)	GGEVO25-75E	25ft	20	22	×							

Pocket Tapes Double-faced Scale



Best balance for "Durability" and "Thinness"

DURA COAT is developed from New technology of polyester extrusion coating for tapes. Graduation is heart of Pocket tapes, **DURA COAT** is **10 times** more durable than our standard coating.

NEO DURA SERIES and **PRO DURA SERIES** has scales on both sides. It makes easily to measure the heights. Come with patent pending, *4-rivet diamond-pattern hook. (*19&25 mm width) It is KDS's 80 years' pride with the tapes.



Mark

Eraser Test

Objective: To test the durability of coating on measuring tape

Testing Method :

- Step 1 Setting up Sand Eraser at 90 degree
- Step 2 4kgs of weight is loaded on the eraser
- Step 3 Revolves under the eraser

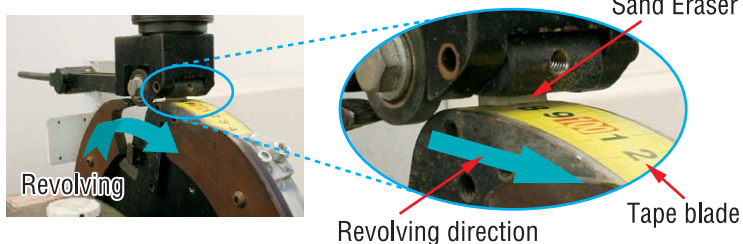

TEST RESULT

Based on our internal test

" **DURA COAT** is 10 times Longer Usage "

Normal Coat		DURA COAT	
KDS after 100 times	Brand A after 100 times	KDS after 350 times	Brand A after 350 times
KDS after 1000 times	Brand A after 1000 times	KDS after 1000 times	Brand A after 1000 times
KDS after 100 times	Brand B after 100 times	KDS after 350 times	Brand B after 350 times
KDS after 1000 times	Brand B after 1000 times	KDS after 1000 times	Brand B after 1000 times

Pocket Tapes Double-faced Scale

NEO DURA SERIES

10 times Durability compare with KDS conventional coating

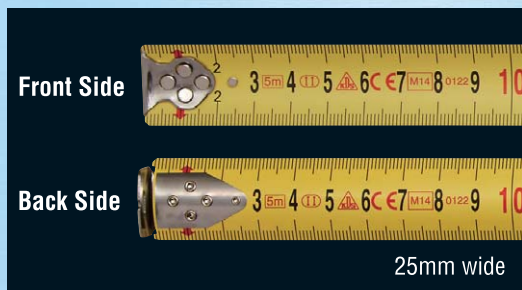

Hook protector



Fit in your palm

NEO DURA-G (Gum)



Non-slip rubberized grip fits in your palm and protect case from damages.
Both-sides print scale with Dura Coating technologies.
Soon to be your favorite tape.
Featuring a unique KDS Double-lock system, pulling up on the lock tab for easy brake, while pushing down engages the full lock.



	Cat.No.	Length	Width	QTY/Box	QTY/Carton	N.W. (kgs)	G.W. (kgs)	M3	"Carton size (cm) D x W x H"	Stock available in Rotterdam
EU	DVG19-30EU	3m	19mm	4	40	8	10	0.030	20 x 64 x 23	<input type="radio"/>
	DVG19-50EU	5m	10			12	<input type="radio"/>			
	DVG25-50EU		25mm			13	15			<input type="radio"/>
ME	DVG19-35ME	3.5m x 12ft	19mm			8	10			<input type="checkbox"/>
	DVG19-55ME	5.5m x 18ft	10			12	<input type="checkbox"/>			
	DVG25-50ME	5m x 16ft	25mm			13	15			<input type="checkbox"/>
	DVG25-75ME	7.5m x 25ft	18	20	<input type="checkbox"/>					
E (inch)	DVG25-75E	25ft							<input type="checkbox"/>	

※ME graduation series come with different Plate label design

NEO DURA-M (Metal)



Fashionable and stylish outlook.
Featuring a unique KDS Double-lock system, pulling up on the lock tab for easy brake, while pushing down engages the full lock.



	Cat.No.	Length	Width	QTY/Box	QTY/Carton	N.W. (kgs)	G.W. (kgs)	M3	"Carton size (cm) D x W x H"	Stock available in Rotterdam
EU	DVZ19-30EU	3m	19mm	6	60	10	12	0.035	34 x 57 x 18	<input type="checkbox"/>
	DVZ19-50EU	5m	12			14	<input type="checkbox"/>			
	DVZ25-50EU		25mm			18	20			<input type="checkbox"/>
	DVZ25-80EU	8m	4	40	19	21	0.030	23 x 63 x 21	<input type="radio"/>	

Pocket Tapes Double-faced Scale

PRO DURA SERIES

10 times Durability

compare with KDS conventional coating

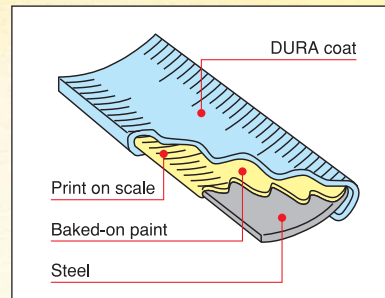
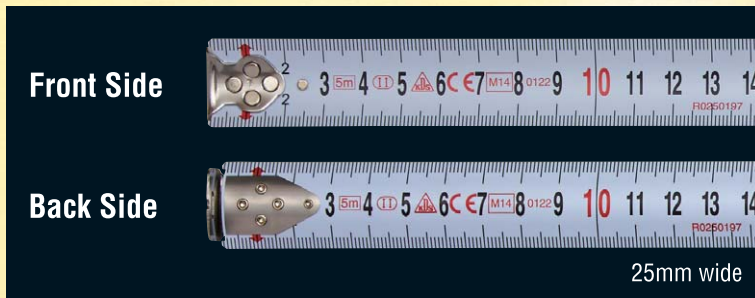

PRO DURA 16

Compact size pocket tape with Dura Coating technologies.



	Cat.No.	Length	Width	QTY/Box	QTY/ Carton	N.W. (kgs)	G.W. (kgs)	M3	"Carton size (cm) D x W x H"	Stock available in Rotterdam
EU	PDX16-30EU	3m	16mm	6	60	9	11	0.035	34 x 57 x 18	○
	PDX16-50EU	5m				10	12			×
ME	PDX16-35ME	3.5m x 12ft.	16mm	6	60	9	11	0.035	34 x 57 x 18	×
	PDX16-55ME	5.5m x 18ft.				10	12			×

PRO DURA 19/25

Popular size pocket tape with Dura Coating technologies.

Featuring a unique KDS Double-lock system, pulling up on the lock tab for easy brake, while pushing down engages the full lock.



	Cat.No.	Length	Width	QTY/Box	QTY/ Carton	N.W. (kgs)	G.W. (kgs)	M3	"Carton size (cm) D x W x H"	Stock available in Rotterdam
EU	PDX19-30EU	3m	19mm	6	60	10	12	0.035	34 x 57 x 18	×
	PDX19-50EU	5m				12	14			○
	PDX25-50EU	5m	25mm			18	20			○
	PDX25-75EU	7.5m				25	27			○
ME	PDX25-80EU	8m	25mm	4	40	19	21	0.030	23 x 63 x 21	×
	PDX19-35ME	3.5m x 12ft.				19mm	6			60
	PDX19-55ME	5.5m x 18ft.	12	14	×					
	PDX25-50ME	5.0m x 16ft.	25mm	18	20			×		
PDX25-75ME	7.5m x 25ft.	25		27	×					
E (inch)	PDX25-75E	25ft.	25mm	6	60	25	27	0.035	34 x 57 x 18	×

Pocket Tapes Double-faced Scale



Stainless 19



The ultimate tape measure! Includes the superior features of the new **Double-lock** tape measure, but with **stainless steel** blade, spring and hook.

Perfect for wet or dry environments.

The tape itself has scales on both sides to easily measure heights, and comes with a strong, **4-rivet** diamond-pattern hook.



	Cat.No.	Length	Width	QTY/Box	QTY/Carton	N.W. (kgs)	G.W. (kgs)	M3	"Carton size (cm) D x W x H"	Stock available in Rotterdam
EU	SS19-50EU	5m	19mm	6	60	14	16	0.035	35 x 57 x 18	×
JIS	SS19-35B	3.5m								×
JIS	SS19-55B	5.5m								×

Stainless 25



The ultimate tape measure! Includes the superior features of the new **Double-lock** tape measure, but with **stainless steel** blade, spring and hook.

Perfect for wet or dry environments.

The tape itself has scales on both sides to easily measure heights, and comes with a strong, **4-rivet** diamond-pattern hook.



	Cat.No.	Length	Width	QTY/Box	QTY/Carton	N.W. (kgs)	G.W. (kgs)	M3	"Carton size (cm) D x W x H"	Stock available in Rotterdam
EU	SS25-50EU	5m	25mm	4	40	13	15	0.035	34 x 57 x 18	×
	SS25-80EU	8m				16	18	0.030	23 x 63 x 21	×
JIS	SS25-55B	5.5m				13	15	0.035	34 x 57 x 18	×
	SS25-75B	7.5m				16	18			×

Pocket Tapes Double-faced Scale

Both side Print 19



The KDS **Double-lock** leads the way in measuring tape development.

Featuring a unique double-lock system, **pulling up** on the locking tab applies an easy rewind brake, while **pushing down** engages the full lock. The round design fits nicely in the palm. The tape itself has scales on both side to easily measure heights, and comes with a strong, diamond-pattern hook.

4-rivet diamond-pattern hook.



	Cat.No.	Length	Width	QTY/Box	QTY/ Carton	N.W. (kgs)	G.W. (kgs)	M3	"Carton size (cm) D x W x H"	Stock available in Rotterdam
EU	ZS19-50EU	5m	19mm	6	60	13	15	0.035	20 x 61 x 29	×
	ZS19-70EU	7m				18	20			×
JIS	ZS19-55B	5.5m	19mm	6	60	13	15	0.035	20 x 61 x 29	×
	ZS19-75B	7.5m				18	20			×

Both side Print 22



The KDS **Double-lock** leads the way in measuring tape development.

Featuring a unique double-lock system, **pulling up** on the locking tab applies an easy rewind brake, while **pushing down** engages the full lock. The round design fits nicely in the palm. The tape itself has scales on both side to easily measure heights, and comes with a strong, diamond-pattern hook.

4-rivet diamond-pattern hook.



	Cat.No.	Length	Width	QTY/Box	QTY/ Carton	N.W. (kgs)	G.W. (kgs)	M3	"Carton size (cm) D x W x H"	Stock available in Rotterdam
EU	ZS22-50EU	5m	22mm	6	60	15	17	0.035	20 x 61 x 29	○
	ZS22-70EU	7m				20	22			×
JIS	ZS22-55B	5.5m	22mm	6	60	15	17	0.035	20 x 61 x 29	×
	ZS22-75B	7.5m				20	22			×

Both side Print 25



The KDS **Double-lock** leads the way in measuring tape development.

Featuring a unique double-lock system, **pulling up** on the locking tab applies an easy rewind brake, while **pushing down** engages the full lock. The round design fits nicely in the palm. The tape itself has scales on both side to easily measure heights, and comes with a strong, diamond-pattern hook.

4-rivet diamond-pattern hook.



	Cat.No.	Length	Width	QTY/Box	QTY/ Carton	N.W. (kgs)	G.W. (kgs)	M3	"Carton size (cm) D x W x H"	Stock available in Rotterdam
EU	ZS25-50EU	5m	25mm	4	40	11	13	0.035	20 x 61 x 29	×
	ZS25-80EU	8m				16	18	0.030	23 x 63 x 21	○
	ZS25-10EU	10m				22	24	0.030	23 x 63 x 21	○
JIS	ZS25-55B	5.5m	25mm	4	40	11	13	0.035	20 x 61 x 29	×
	ZS25-75B	7.5m				16	18			×

Pocket Tapes single-faced Scale

Mega Lock 13/16/19/25



A sturdy lock button locks the tape in any position and retracts the tape smoothly into the case.



	Cat.No.	Length	Width	QTY/Box	QTY/ Carton	N.W. (kgs)	G.W. (kgs)	M3	"Carton size (cm) D x W x H"	Stock available in Rotterdam	
EU	S13-20EU	2m	13mm	6	120	13	15	0.056	37 x 56 x 27	×	
	S13-30EU	3m				16	18			×	
	S16-50EU	5m	16mm			60	28			30	×
	S19-50EU		19mm				17			19	×
	S25-50EU		25mm				26			28	×
ME	S13-20YMEB	2m x 6ft.	13mm	6	120	13	15	0.056	37 x 56 x 27	×	
	S13-30YMEB	3m x 10ft.				16	18			×	
	S16-35YMEB	3.5m x 12ft.	16mm			22	24			×	
	S16-50YMEB	5m x 16ft.				28	30			×	
	S19-55YMEB	5.5m x 18ft.				19mm	17			19	×
	S19-75YMEB	7.5m x 25ft.	18				20			×	
	S25-55YMEB	5.5m x 18ft.	25mm				26			28	×
	S25-75YMEB	7.5m x 25ft.				28	30			×	



Jumbo 19



Heavy duty traditional model for professionals.

The **on-off, switching lock** button locks the tape in any position at any point.



	Cat.No.	Length	Width	QTY/Box	QTY/ Carton	N.W. (kgs)	G.W. (kgs)	M3	"Carton size (cm) D x W x H"	Stock available in Rotterdam
EU	JM19-50EU	5m	19mm	6	60	15	17	0.047	23 x 65 x 32	×
ME	JM19-55YMEB	5.5m x 18ft.				15	17			×
JIS	JM19-35WB	3.5m				13	15			○
	JM19-55WB	5.5m				15	17			○



Giant 25



Heavy duty traditional model for professionals.

The **on-off, switching lock** button locks the tape in any position at any point.



	Cat.No.	Length	Width	QTY/Box	QTY/ Carton	N.W. (kgs)	G.W. (kgs)	M3	"Carton size (cm) D x W x H"	Stock available in Rotterdam
EU	GT25-50EU	5m	25mm	6	60	20	22	0.047	23 x 65 x 32	×
	GT25-80EU	8m				26	28			×
ME	GT25-55YMEB	5.5m x 18ft.				20	22			×
	GT25-75YMEB	7.5m x 25ft.				25	27			×
JIS	GT25-55WB	5.5m				20	22			○
	GT25-75WB	7.5m				25	27			○



Pocket Tapes single-faced Scale

New NeoLock 13/16



Compact size pocket tape with stopping device. Suitable for the stationary and DIY friends.



	Cat.No.	Length	Width	QTY/Box	QTY/Carton	N.W.(kgs)	G.W.(kgs)	M3	*Carton size (cm) D x W x H	Stock available in Rotterdam
EU	S13-20NEU	2m	13mm	6	120	10	12	0.064	40 x 57 x 28	<input type="radio"/>
	S16-30NEU	3m	16mm			18	20			<input type="radio"/>
	S16-50NEU	5m	16mm			24	26			<input type="radio"/>
ME	S13-20NYMEB	2m x 6ft.	13mm			10	12			<input checked="" type="checkbox"/>
	S16-35NYMEB	3.5m x 12ft.	16mm			18	20			<input checked="" type="checkbox"/>
	S16-50NYMEB	5m x 16ft.	16mm			24	26			<input checked="" type="checkbox"/>
JIS	S13-20NB	2m	13mm	10	12	<input checked="" type="checkbox"/>				
	S16-35NB	3.5m	16mm	18	20	<input checked="" type="checkbox"/>				
	S16-55NB	5.5m	16mm	24	26	<input checked="" type="checkbox"/>				

NeoLock 13/16



The on-off, switching lock button locks the tape in position at any point and also controls retraction into the case.



	Cat.No.	Length	Width	QTY/Box	QTY/Carton	N.W.(kgs)	G.W.(kgs)	M3	*Carton size (cm) D x W x H	Stock available in Rotterdam
EU	KS13-20EU	2m	13mm	6	120	13	15	0.064	40 x 57 x 28	<input type="radio"/>
	KS16-30EU	3m	16mm			20	22			<input type="radio"/>
	KS16-50EU	5m	16mm			29	31			<input type="radio"/>
ME	KS13-20YMEB	2m x 6ft.	13mm			13	15			<input checked="" type="checkbox"/>
	KS16-35YMEB	3.5m x 12ft.	16mm			22	24			<input checked="" type="checkbox"/>
	KS16-50YMEB	5m x 16ft.	16mm			29	31			<input checked="" type="checkbox"/>
JIS	KS13-20B	2m	13mm	13	15	<input type="radio"/>				
	KS16-35B	3.5m	16mm	22	24	<input type="radio"/>				
	KS16-55B	5.5m	16mm	29	31	<input type="radio"/>				

NeoLock 19/25



A sturdy lock button locks the tape in any position and retracts the tape smoothly into the case.



Rugged diamond-pattern (4-rivet)hook tip.

	Cat.No.	Length	Width	QTY/Box	QTY/Carton	N.W.(kgs)	G.W.(kgs)	M3	*Carton size (cm) D x W x H	Stock available in Rotterdam		
NeoLock 19												
EU	KS19-50EU	5m	19mm	6	60	15	17	0.032	20 x 62 x 26	<input type="radio"/>		
	KS19-70EU	7m				18	20			<input checked="" type="checkbox"/>		
ME	KS19-55YMEB	5.5m x 18ft.				15	17			<input checked="" type="checkbox"/>		
	KS19-75YMEB	7.5m x 25ft.				18	20			<input checked="" type="checkbox"/>		
JIS	KS19-35B	3.5m				14	16			<input type="radio"/>		
	KS19-55B	5.5m				15	17			<input type="radio"/>		
	KS19-75B	7.5m	18	20	<input checked="" type="checkbox"/>							
NeoLock 25												
EU	KS25-50EU	5m	25mm	6	60	18	20	0.035	20 x 61 x 29	<input checked="" type="checkbox"/>		
	KS25-80EU	8m				27	29			0.064	40 x 57 x 28	<input checked="" type="checkbox"/>
	KS25-10EU	10m				31	33					<input checked="" type="checkbox"/>
ME	KS25-55YMEB	5.5m x 18ft.				18	20	0.035	20 x 61 x 29	<input checked="" type="checkbox"/>		
	KS25-75YMEB	7.5m x 25ft.				25	27			<input checked="" type="checkbox"/>		
	KS25-10YMEB	10m x 33ft.				28	30			0.064	40 x 57 x 28	<input checked="" type="checkbox"/>
JIS	KS25-55B	5.5m	18	20	0.035	20 x 61 x 29	<input type="radio"/>					
	KS25-75B	7.5m	25	27			<input type="radio"/>					

Pocket Tapes With push-pull type

Free 13/16



Compact size pocket tape with smooth contoured line, the case fits comfortably in the hand. Most popular in the stationery and DIY fields. **Without belt-clip.**

	Cat.No.	Length	Width	QTY/Box	QTY/ Carton	N.W. (kgs)	G.W. (kgs)	M3	Carton size (Cm) D x W x H	Stock available in Rotterdam				
EU	KF13-20EU	2m	13mm	6	120	8	10	0.064	40 x 57 x 28	○				
	KF16-30EU	3m	16mm			17	19							
	KF16-50EU	5m				23	25							
JIS	KF13-20	2m	13mm			8	10			17	19	23	25	×
	KF16-35	3.5m	16mm			17	19							
	KF16-55	5.5m				23	25							



Compact Free 19



Compact size pocket tape **with convenient stop button and belt-clip.** Rugged diamond-pattern (4-revet) hook tip

	Cat.No.	Length	Width	QTY/Box	QTY/ Carton	N.W. (kgs)	G.W. (kgs)	M3	Carton size (Cm) D x W x H	Stock available in Rotterdam
EU	CF19-50EU	5m	19mm	6	60	15	17	0.035	20 x 61 x 29	×
	CF19-70EU	7m				18	20			
JIS	F19-55B	5.5m				15	17			
	F19-75B	7.5m				18	20			



Compact Free 22



Compact size pocket tape **with convenient stop button and belt-clip.** Rugged diamond-pattern (4-revet) hook tip

	Cat.No.	Length	Width	QTY/Box	QTY/ Carton	N.W. (kgs)	G.W. (kgs)	M3	Carton size (Cm) D x W x H	Stock available in Rotterdam
EU	CF22-50EU	5m	22mm	6	60	16	18	0.035	20 x 61 x 29	×
JIS	F22-55B	5.5m								



Compact Free 25



Push-Pull type heavy duty pocket tape **with convenient stop button and belt-clip.** 25mm (1inch) wide tape with superior horizontal stand out.

	Cat.No.	Length	Width	QTY/Box	QTY/ Carton	N.W. (kgs)	G.W. (kgs)	M3	Carton size (Cm) D x W x H	Stock available in Rotterdam
EU	CF25-50EU	5m	25mm	6	60	18	20	0.035	20 x 61 x 29	×
JIS	F25-55B	5.5m								
	F25-75B	7.5m								



Pocket Tapes



PRONEXT 19/25



New Generation Pocket Tapes for multi-users. Ergonomics Design case fits in your palm and End-HOOK Protector is in ideal position. 4-Colors variation (BLACK / YELLOW / RED / BLUE) in one display Box. Colorful pocket tape will meet user's preference.

	Cat.No.	Length	Width	QTY/Box	QTY/ Carton	N.W. (kgs)	G.W. (kgs)	M3	Carton size (Cm) D x W x H	Stock available in Rotterdam
EU	PX25-50EU	5m	25mm	12pcs. In POP	24	7	8	0.017	30 x 49 x 12	○
ME	PX19-55ME	5.5m x 18ft.	19mm	carton box		6	7			×



Pocket Tape Holder

NEW



KDS Slot-in tape holder is an essential tool to support your outfield work. It fits KDS pocket tapes (Width: 19, 22, 25 and 27mm) only.



Cat.No.	QTY/Box	QTY/ Carton	N.W. (kgs)	G.W. (kgs)	M3	Carton size (Cm) D x W x H	Stock available in Rotterdam
SH-01	10	60	4	5	0.032	39 x 47 x 17	×

Mini-Rod



Mini-Rod is extremely useful for taking short distance photo-records, and survey work, having two kinds of special 5mm graduations on both side of the tape.

Cat.No.	Length	Width	QTY/Box	QTY/ Carton	N.W. (kgs)	G.W. (kgs)	M3	Carton size (Cm) D x W x H	Stock available in Rotterdam
MN25-02	2m Rod	25mm	10	50	6	8	0.017	21 x 41 x 19	×
MN25-02C	2m + 2m Rod								
MN25-02E	6 1/2 feet								
MN25-02ET	6 1/2ft (10th)								

Pocket Tapes

Steel Diameter tape



Diameter rules provide accuracy in an ordinary linear measurement plus diameter measurement.

F10-02DM

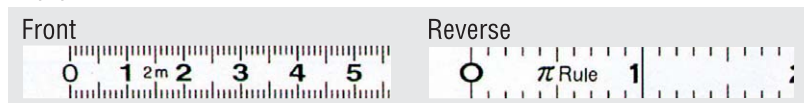

Cat.No.	Length	Width	QTY/Box	QTY/ Carton	N.W. (kgs)	G.W. (kgs)	M3	Carton size (Cm) D x W x H	Stock available in Rotterdam
F10-02DM	2m								○
F10-02EP	64ths	10mm	12	240	14	16	0.017	21 x 41 x 19	×
F10-02EPD	100ths								

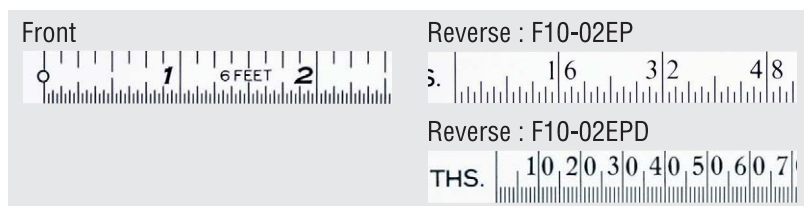

Steel Flat tape

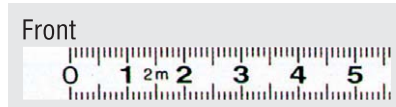

KDS Flat rules are most useful in machinery or dress-measuring applications.

Cat.No.	Length	Width	QTY/Box	QTY/ Carton	N.W. (kgs)	G.W. (kgs)	M3	Carton size (Cm) D x W x H	Stock available in Rotterdam
F10-02	2m	10m	12	240	14	16	0.017	21 x 41 x 19	×

Rain Drop



A specially designed slim & lightweight pocket tape. Rain Drop is available in 2 colors, Yellow and Red and each is fitted with a keychain for ease in carrying.

Cat.No.	Length	Width	QTY/Box	QTY/ Carton	N.W. (kgs)	G.W. (kgs)	M3	Carton size (Cm) D x W x H	Stock available in Rotterdam
RA06-10YE	1m	6mm	12	60	2	3	0.012	17 x 43 x 17	×
RA06-10RE					3	4			
RA06-20YE	2m				3	4			
RA06-20RE									

Setting Measure

Reverse graduation also available



ST13-01BP

Stick-on Tape Measure with self-adhesive.

Use as customized measure for workbenches, saw tables machinery, desks, countertops, poles, walls, columns, etc.

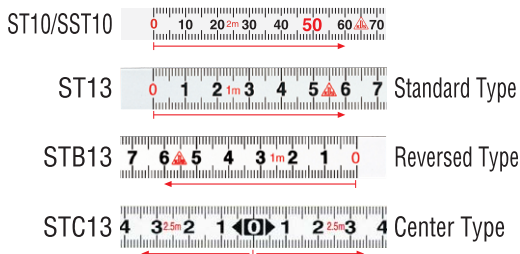

Cat.No.	Length	Width	QTY/Box	QTY/ Carton	N.W. (kgs)	G.W. (kgs)	M3	Carton size (Cm) D x W x H	Stock available in Rotterdam
ST10-02BP	2m	10mm			7	9			
SST10-02BP					4	5			
ST13-01BP	1m	13mm	10	100	4	5	0.024	34 x 49 x 15	×
ST13-02BP	2m				7	9			
ST13-05BP	5m				9	11			
STB13-01BP	1m				4	5			
STB13-02BP	2m				7	9			
STB13-05BP	5m				9	11			
STC13-05BP									

Pocket Tapes



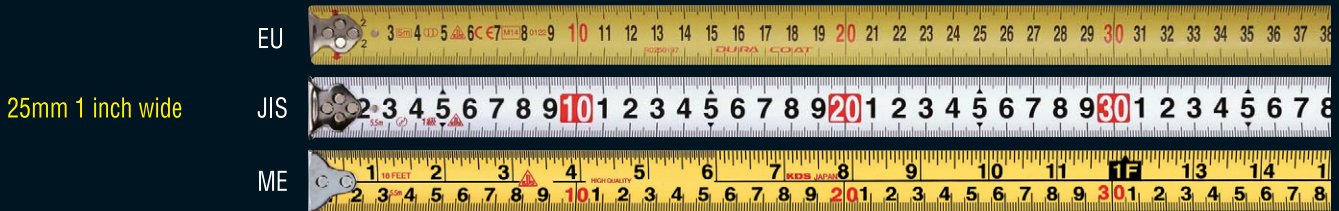
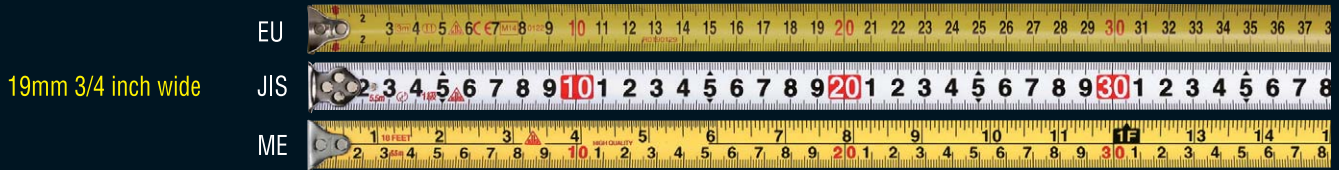









Marking specifications and graduations















Double faced Tape













Pocket Tapes packaging-1

Name	Graduation	Cat. No.	Length	Width	Quantity/Box	Quantity/Carton	
	EU	GGEVO19-55EU	5.5m	19mm		40	
		GGEVO25-55EU		25mm			
		GGEVO25-75EU	7.5m	4			
	GGEVO25-10EU	10m	19mm				
	ME	GGEVO19-55ME					5.5m x 18ft.
		GGEVO25-55ME	7.5m x 25ft.				
	E(inch)	GGEVO25-75ME	10m x 33ft.	4			
GGEVO25-75E		25ft.					
	EU	DVG19-30EU	3m	19mm		40	
		DVG19-50EU	5m	25mm			
		DVG25-50EU		4			
	ME	DVG19-35ME	3.5m x 12ft.				19mm
		DVG19-55ME	5.5m x 18ft.				25mm
		DVG25-50ME	5.0m x 16ft.				
	E(inch)	DVG25-75ME	7.5m x 25ft.	4			
DVG25-75E		25ft.					
	EU	DVZ19-30EU	3m	19mm		60	
		DVZ19-50EU	5m	25mm			
		DVZ25-50EU					4
	DVZ25-80EU	8m	※1	40			
	EU	PDX16-30EU	3m	16mm		60	
		PDX16-50EU	5m	19mm			
		PDX19-30EU	3m				4
		PDX19-50EU	5m	※1			
		PDX25-50EU	7.5m	25mm			
		PDX25-75EU					8m
	ME	PDX16-35ME	3.5m x 12ft.	16mm			6
		PDX16-55ME	5.5m x 18ft.	19mm			
		PDX19-35ME	3.5m x 12ft.				
		PDX19-55ME	5.5m x 18ft.	6			
		PDX25-50ME	5.0m x 16ft.				
PDX25-75ME	7.5m x 25ft.	25mm					
E(inch)	PDX25-75E		25ft.	4			
	EU	SS19-50EU	5m		19mm		60
		SS25-50EU	8m	25mm			
		SS25-80EU		※1	40		
	JIS	SS19-35B	3.5m	19mm	6		
		SS19-55B	5.5m	25mm			
		SS25-55B					
SS25-75B	7.5m	4					
	EU		ZS19-50EU	5m	19mm		60
		ZS19-70EU	7m	22mm			
		ZS22-50EU	5m		4		
		ZS22-70EU	7m	※1			
	JIS	ZS25-50EU	5m	19mm			
		ZS25-80EU	8m		25mm		
		ZS25-10EU	10m	6			
		ZS19-55B	5.5m		22mm		
ZS19-75B	7.5m	4					
ZS22-55B	5.5m		25mm				
ZS22-75B	7.5m	60					
ZS25-55B	5.5m		4				
ZS25-75B	7.5m	40					





Pocket Tapes packaging-2

Name	Graduation	Cat. No.	Length	Width	Quantity/Box	Quantity/Box	Quantity/Box
Mega Lock 13/16/19/25 	EU	S13-20EU	2m	13mm	6		
		S13-30EU	3m				
		S16-50EU	5m	16mm			
		S19-50EU		19mm			
		S25-50EU		25mm			
	ME	S13-20YMEB	2m x 6ft.	13mm			
		S13-30YMEB	3m x 10ft.				
		S16-35YMEB	3.5m x 12ft.	16mm			
		S16-50YMEB	5.0m x 16ft.				
		S19-55YMEB	5.5m x 18ft.	19mm			
		S19-75YMEB	7.5m x 25ft.				
		S25-55YMEB	5.5m x 18ft.				
		S25-75YMEB	7.5m x 25ft.	25mm			
Jumbo 19 Giant 25 	EU	JM19-50EU	5m	19mm	6		
		GT25-50EU		25mm			
		GT25-80EU	8m				
	ME	JM19-55YMEB	5.5m x 18ft.	19mm			
		GT25-55YMEB		25mm			
		GT25-75YMEB	7.5m x 25ft.				
	JIS	JM19-35WB	3.5m	19mm			
		JM19-55WB	5.5m	25mm			
		GT25-55WB					
GT25-75WB	7.5m						
New NeoLock 13/16 	EU	S13-20NEU	2m	13mm	6		
		S16-30NEU	3m	16mm			
		S16-50NEU	5m				
	ME	S13-20NYMEB	2m x 6ft.	13mm			
		S16-35NYMEB	3.5m x 12ft.	16mm			
		S16-50NYMEB	5.0m x 16ft.				
	JIS	S13-20NB	2m	13mm			
		S16-35NB	3.5m	16mm			
		S16-55NB	5.5m				
NeoLock 13/16 	EU	KS13-20EU	2m	13mm	6		
		KS16-30EU	3m	16mm			
		KS16-50EU	5m				
	ME	KS13-20YMEB	2m x 6ft.	13mm			
		KS16-35YMEB	3.5m x 12ft.	16mm			
		KS16-50YMEB	5.0m x 16ft.				
	JIS	KS13-20B	2m	13mm			
		KS16-35B	3.5m	16mm			
		KS16-55B	5.5m				

Pocket Tapes packaging-3

Name	Graduation	Cat. No.	Length	Width	Quantity/Box	Quantity/Carton
	EU	KS19-50EU	5m	19mm	6	60
		KS19-70EU	7m	25mm		
		KS25-50EU	5m			
		KS25-80EU	8m			
		KS25-10EU	10m			
	ME	KS19-55YMEB	5.5m x 18ft.			
		KS19-75YMEB	7.5m x 25ft.	25mm		
		KS25-55YMEB	5.5m x 18ft.			
		KS25-75YMEB	7.5m x 25ft.			
		KS25-10YMEB	10m x 33ft.			
	JIS	KS19-35B	3.5m			
		KS19-55B	5.5m	25mm		
KS19-75B		7.5m				
KS25-55B		5.5m				
KS25-75B		7.5m				
	EU	KF13-20EU	2m		13mm	6
		KF16-30EU	3m	16mm		
		KF16-50EU	5m	16mm		
	JIS	KF13-20	2m			
		KF16-35	3.5m			
		KF16-55	5.5m			
	EU	CF19-50EU	5m	19mm	6	60
		CF19-70EU	7m	25mm		
		CF22-50EU	5m			
		CF25-50EU	5m			
	JIS	F19-55B	5.5m			
		F19-75B	7.5m	25mm		
		F22-55B	5.5m			
		F25-55B	5.5m			
	EU	PX25-50EU	5m		19mm	12
	ME	PX19-55ME	5.5m x 18ft.	19mm	12	24
		SH-01			10	60
		MN25-02	2m Rod	25mm	10	50
		MN25-02C	2m+2m Rod			
		MN25-02E	6 1/2feet			
		MN25-02ET	6 1/2ft(10th)			
		F10-02DM	2m	10mm	12	240
		F10-02EP	64ths			
		F10-02EPD	100ths			
		F10-02	2m			
		RA06-10YE	1m	6mm	12	60
		RA06-10RE				
		RA06-20YE				
		RA06-20RE				
		ST10-02BP	2m	10mm	10	100
		SST10-02BP				
		ST13-01BP	1m	13mm		
		ST13-02BP	2m			
		ST13-05BP	5m			
		STB13-01BP	1m			
		STB13-02BP	2m			
		STB13-05BP	5m			
		STC13-05BP	5m			
		RSB-2BP	2m	16mm	6	60

Long Tapes packaging

Name	Cat. No.	Length	Width	Quantity/Box	Quantity/Carton
Speed Tecron-10	SST10-30	30m	10mm		
	SST10-50	50m			
Speed Tecron-13	ST13-30	30m	13mm		5
	ST13-50	50m			
	ST13-30ME	20m x 100ft.			
	ST13-50ME	50m x 164ft.			
	ST13-30ME DH	30m x 100ft.			
	ST13-60ME DH	60m x 200ft.			
Tecron-13	TL13-30	30m	13mm		5
	TL13-50	50m			
	TL13-30ME	30m x 100ft.			
	TL13-50ME	50m x 164ft.			
Unilong-13	UL13-30	30m	13mm		5
	UL13-50	50m			
	UL13-30ME	30m x 100ft.			
	UL13-50ME	50m x 164ft.			
Kaclong-10	KL10-10	10m	10mm		6
	KL10-20	20m			
	KL10-30	30m			
	KL10-10ME	10m x 33ft.			
	KL10-20ME	20m x 66ft.			
	KL10-30ME	30m x 100ft.			
Speed Tufmic-12R	SGR12-30	30m	12mm		5
	SGR12-50	50m			
	SGR12-1H	100m			
	SGR12-120	120m			
Tufmic-12C	GK12-10	10m	12mm		10
	GK12-20	20m			
	GK12-30	30m			
Tufmic-12R	GR12-30	30m	12mm		5
	GR12-50	50m			
	GR12-1H	100m			

Long Tapes

SPEED TECRON®
4x Super rewind 1wind-up,4rewinding

Drop-shock resistant elastomer tip

Slip resistant elastomer grip

Speed Tecron-10 "4x Super rewind" Nylon coating stainless steel long tapes

Stainless Steel



Quad-Speed rewind, **extruded nylon coated stainless steel** long tape. Easy to read black and red marking with quick reading meter figures. Standard tension:20°C 50N [Tape thickness: 0.4mm]

Cat.No.	Length	Width	QTY/Box	QTY/Carton	N.W. (kgs)	G.W. (kgs)	M3	Carton size (Cm) D x W x H
SST10-30	30m	10mm	1	5	5	7	0.022	30 x 31 x 23
SST10-50	50m				6	8	0.027	30 x 35 x 26

※ White tape and metric graduation only

Speed Tecron-13 "4x Super rewind" Nylon coating steel long tapes



With the Quad-Speed Tecron, turn the handle once and the tape **rewinds four times!**

And the **nylon coating** on the tape blades means **it's waterproof. 10mm wide tape is also available.** Standard tension:20°C 100N [Tape thickness: 0.45mm]

Cat.No.	Length	Width	QTY/Box	QTY/Carton	N.W. (kgs)	G.W. (kgs)	M3	Carton size (Cm) D x W x H
ST13-30	30m	13mm	1	5	7	9	0.022	30 x 31 x 23
ST13-50	50m				10	12	0.027	30 x 35 x 26
ST13-30ME	30m x 100ft				7	9	0.022	30 x 31 x 23
ST13-50ME	50m x 164ft				10	12	0.027	30 x 35 x 26
* ST13-30ME DH	30m x 100ft				7	9	0.022	30 x 31 x 23
* ST13-60ME DH	60m x 200ft				10	12	0.027	30 x 35 x 26

[* DH: with a Hook]

Long Tapes

Tecron-13

Nylon coating steel long tapes



Multi-purpose, easy to use, **Nylon coating long steel** measuring tapes. Standard tension: 20°C 100N [Tape thickness: 0.45mm]

Cat.No.	Length	Width	QTY/Box	QTY/Carton	N.W. (kgs)	G.W. (kgs)	M3	Carton size (Cm) D x W x H
TL13-30	30m	13mm	1	5	6	8	0.022	30 x 31 x 23
TL13-50	50m				8	10	0.027	30 x 35 x 26
TL13-30ME	30m x 100ft				6	8	0.022	30 x 31 x 23
TL13-50ME	50m x 164ft				8	10	0.027	30 x 35 x 26

Unilong-13

Steel long tapes

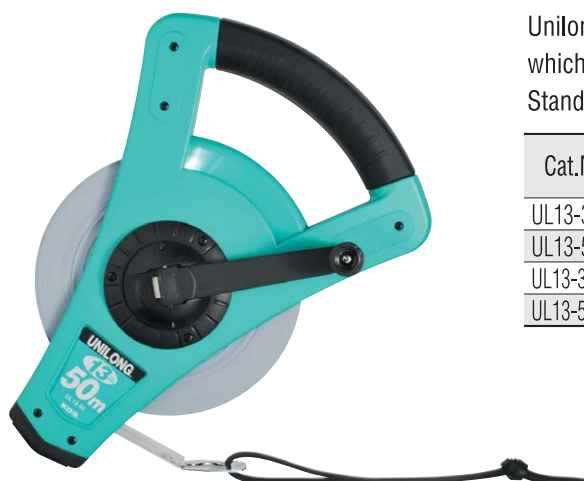

Unilong tapes are made from **hardened and tempered high-carbon steel** which has been treated with phosphate to protect against rust and corrosion. Standard tension: 20°C 100N [Tape thickness: 0.23mm]

Cat.No.	Length	Width	QTY/Box	QTY/Carton	N.W. (kgs)	G.W. (kgs)	M3	Carton size (Cm) D x W x H
UL13-30	30m	13mm	1	5	6	8	0.022	30 x 31 x 23
UL13-50	50m				8	10	0.027	30 x 35 x 26
UL13-30ME	30m x 100ft				6	8	0.022	30 x 31 x 23
UL13-50ME	50m x 164ft				8	10	0.027	30 x 35 x 26

Kaclong-10

Steel long tapes



Economical type of long tape, in an ABS plastic case, and equipped with vinyl wrist strap.

Standard tension: 20°C 20N [Tape thickness: 0.18mm]

Cat.No.	Length	Width	QTY/Box	QTY/Carton	N.W. (kgs)	G.W. (kgs)	M3	Carton size (Cm) D x W x H
KL10-10	10m	10mm	6	24	5	7	0.016	24 x 56 x 12
KL10-20	20m				7	9	0.022	29 x 63 x 12
KL10-30	30m				12	14	0.016	24 x 56 x 12
KL10-10ME	10m x 33ft				5	7		
KL10-20ME	20m x 66ft				7	9		
KL10-30ME	30m x 100ft				12	14	0.022	29 x 63 x 12

Long Tapes

Speed Tufmic-12R

"4x Super rewind" Glass fiber long tapes



With the **Quad-Speed Tufmic**, turn the handle once and the tape **rewinds four times !**

Tufmic **glass-fiber tapes** will not stretch, shrink or cases, and are resistant to water, humidity, temperature and most chemicals.

Highly recommended for civil-engineers, land surveyors, and those who insist on quality instruments. [Tape thickness: 0.48mm]

Cat.No.	Length	Width	QTY/Box	QTY/Carton	N.W. (kgs)	G.W. (kgs)	M3	Carton size (Cm) D x W x H
QUAD-SPEED REWIND				Standard tension 20°C 10N				
SGR12-30	30m	12mm	1	5	5	7	0.027	31 x 33 x 26
SGR12-50	50m				6	8	0.035	31 x 37 x 31
SGR12-1H	100m				9	11	0.052	31 x 45 x 37
SGR12-120	120m				12	14		

Tufmic-12C/12R

Glass fiber long tapes



Capsule type

Open type

Tufmic **glass-fiber tapes** will not stretch, shrink or cases, and are resistant to water, humidity, temperature and most chemicals.

Highly recommended for civil-engineers, land surveyors, and those who insist on quality instruments. [Tape thickness: 0.48mm]

Cat.No.	Length	Width	QTY/Box	QTY/Carton	N.W. (kgs)	G.W. (kgs)	M3	Carton size (Cm) D x W x H
CAPSULE TYPE				Standard tension 20°C 10N				
GK12-10	10m	12mm	1	10	3	5	0.008	14 x 37 x 15
GK12-20	20m				4	6	0.015	18 x 41 x 20
GK12-30	30m				5	7	0.020	21 x 43 x 22
OPEN TYPE				Standard tension 20°C 10N				
GR12-30	30m	12mm	1	10	3	5	0.029	31 x 41 x 23
GR12-50	50m				5	7	0.036	34 x 41 x 26
GR12-1H	100m			5	8	10	0.028	32 x 38 x 23

Walking Measure

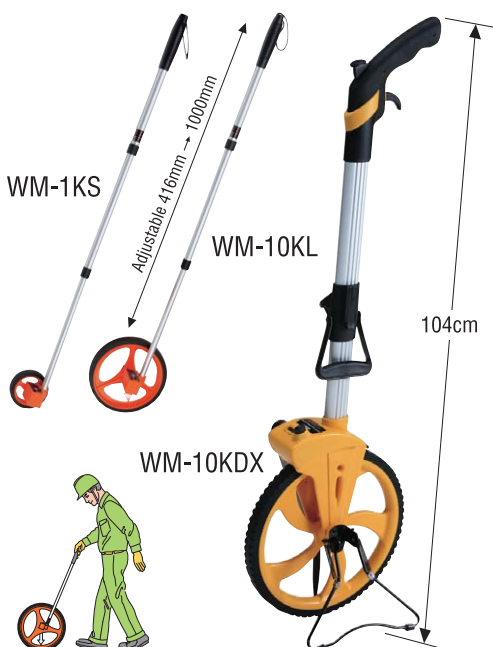

WM-1KS

WM-10KL

WM-10KDX

104cm

Adjustable 416mm ~ 1000mm

*Walking-Measure is the industry's best choice for quick and easy measuring over a variety of surfaces and it accurately measures while you are walking. One person can measure faster than with a tape measure and you are not limited to length of the tapes.

Cat.No.	Min. measuring unit	Max. measuring distance	Wheel dia.	QTY/Box	QTY/Carton	N.W. (kgs)	G.W. (kgs)	M3	Carton size (Cm) D x W x H
WM-1KS	1cm	1km	10cm	6	12	6	8	0.084	62 x 40 x 34
WM-10KL	10cm	10km	20cm			10	12	0.123	58 x 40 x 53
WM-10KDX			32cm	1	4	8	14	0.154	36 x 67 x 64



Low-friction, extruded nylon coated Stainless steel tape

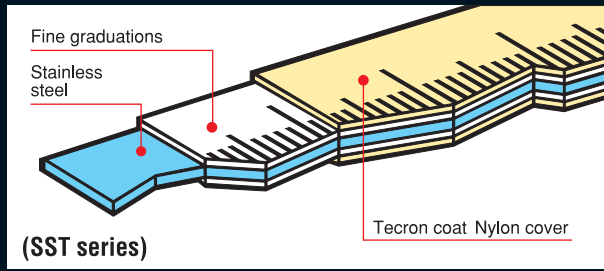

Low-friction, steel tape

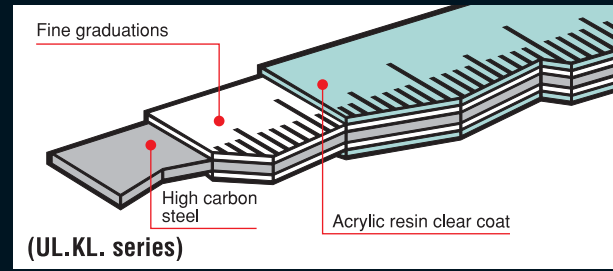

Low-friction, extruded nylon coated steel tape

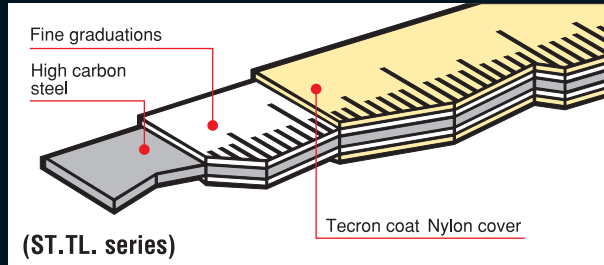

Glass-fiber tape

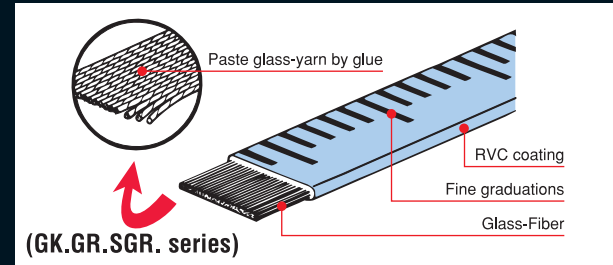

Long Tapes Marking specifications and graduations

10mm wide Kaclong

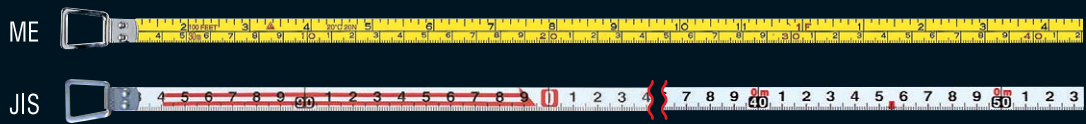

13mm wide Tecron series
(Speed Tecron-13 Steel Tape)

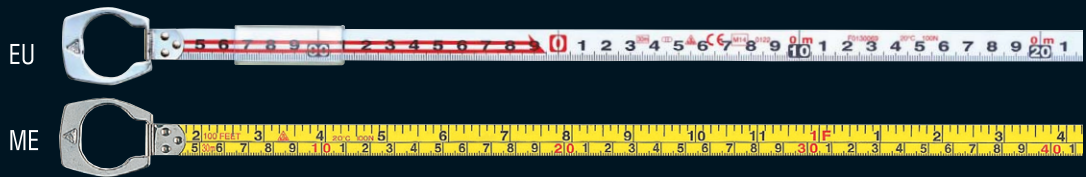

13mm wide Unilong

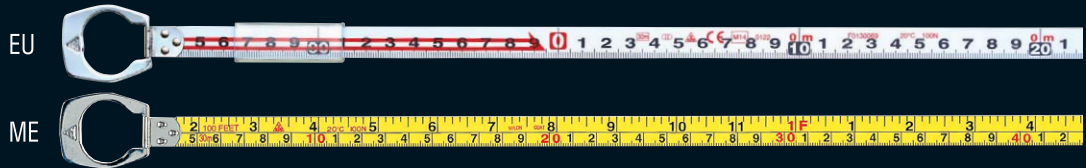

Hook
13mm wide Speed Tecron
(ST13-30ME DH, ST13-60ME DH)



12mm wide
Tufmic Glass Tape



ZERO point manner

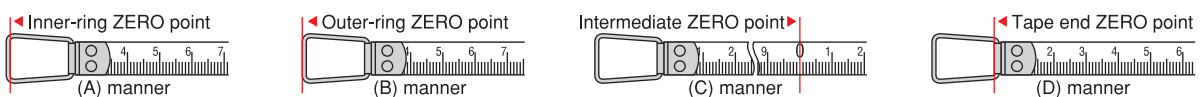

Electronic Products

Tracking Gauge



KDS Tracking Gauge TG-39 is a novel product, equipped with a transparent type optical sensor and a customized micro-computer, providing a digitally displayed tracking gauge that is especially effective in measuring the dimensions of a vehicle body and frame when being realigned.

Detection	Transparent Type Photo-Interrupter
Accuracy	± 3 mm Including a Quantization Error
Min. unit:	0.001m (1 mm)
Measurement Range	In: 0.315 - 3.200 m Out: 1.050 - 3.900 m
Function	Stopping device for each pole, Stop lever in last pole, Zero-set, Hold, 10 Memory reference , Memory input, Display backlight, Selection of measuring unit, Inverse, Selection of automatic power-off, Memory clear
Power	4 pieces of R6 or LR6 Battery
Battery Life	About 45 hours in normal continuous use (Manganese Batteries are used)
Operable Temperature	0 to 40°C Celsius
Weight (Main Unit and Batteries)	1.7 kg
Dimensions	1,000 (L) \times 44 (W) \times 73 (H)
Accessories(Included)	Carrying Case, Four R6 Batteries, Two Holders, Three Types of Tip Attachment

The Digital Tracking Gauge, designed for use in automotive body work.

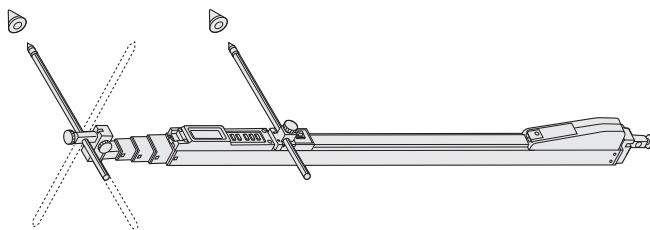
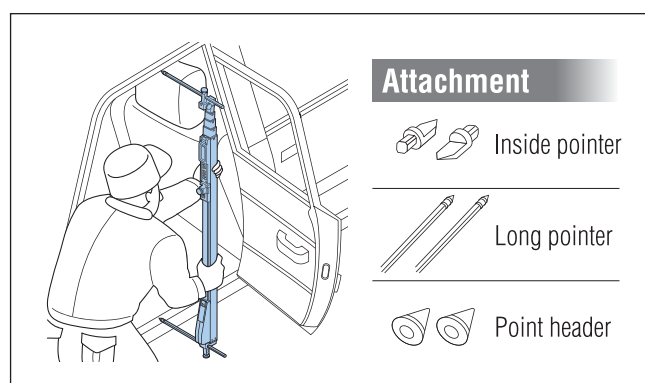

Cat.No.	Inner (pcs.)	Outer (pcs.)	N.W. (kgs)	G.W. (kgs)	M3	Carton size (Cm) D x W x H
TG-39	1	2	4	6	0.021	12 x 104 x 17

Electronic Products

Digital Pole Measures

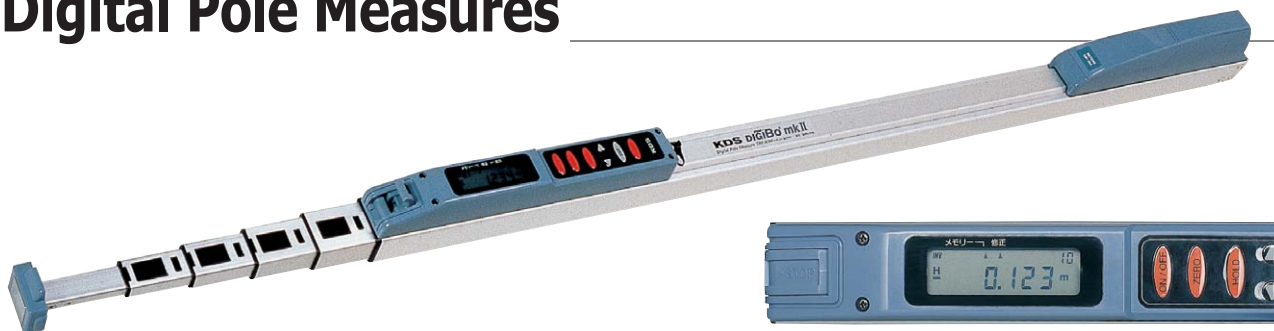

Digital Pole Measures are an excellent way to measure diagonal and inside length.

Six sectional measuring rod **with 10 memories.**

Cat.No.	Inner (pcs.)	Outer (pcs.)	N.W. (kgs)	G.W. (kgs)	M3	Carton size (Cm) D x W x H
DM-20	1	4	5	7	0.024	25 x 60 x 16
DM-40			7	9	0.038	25 x 93 x 16
DM-50			9	11	0.045	25 x 110 x 16
DM-60			10	12	0.051	25 x 127 x 16

Digital Pole Measures-S



Simple model of Digital Pole Measures **without memory function.**

Each of telescoping rods provide accurate measurement and display.

Cat.No.	Inner (pcs.)	Outer (pcs.)	N.W. (kgs)	G.W. (kgs)	M3	Carton size (Cm) D x W x H
DMN-40	1	4	7	9	0.038	25 x 93 x 16
DMN-50			9	11	0.045	25 x 110 x 16

Pole-type measure makes your work easy !

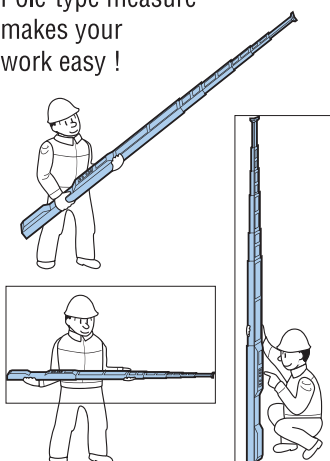

Cat. No.	DM-20	DM-40	DM-50	DM-60	DMN-40	DMN-50
Min. length	0.550m	0.880m	1.050m	1.220m	0.880m	1.050m
Max. length	2.000m	4.000m	5.000m	6.000m	4.000m	5.000m
Outside dimension	550 X 44 X 73mm	880 X 44 X 73mm	1050 X 44 X 73mm	1220 X 44 X 73mm	880 X 44 X 73mm	1050 X 44 X 73mm
Weight	1.2kg	1.7kg	1.95kg	2.2kg	1.7kg	1.95kg
Detection	Transmissive Photo Interrupter					
Accuracy	±2mm(including quantization error)					
Min. unit	0.001m (1 mm)					
Display	Digital 6 digit, LCD display					
Operable Temperature	0 to 40°C Celsius					
Power	4 pieces of R6 or LR6 Battery					
Battery life	About 45 hours in normal continuous use (Manganese Batteries are used)					
Accessories	Exclusive carrying case, 4 pieces of R6 battery, Instruction Manual					
Function						
Memory references	10 memory				no	
Stopping device of each pole					Yes	
Stop lever in last pole					Yes	
Zero-set					Yes	
Hold (Temporary hold of displayed value)					Yes	
Inverse	Yes				no	
Automatic power saving	5 min, 30 min and cancellation				5 min	
Selection of measuring unit	Metric, inch, Sixteenths(1/16) and 10THS/100THS of feet				Metric only	
Display backlight	Yes					

Electronic Products

Digital Wall detector



The Digital Wall Detectors join the KDS Layout Tools line!
 Detects metal objects in the wall by simply pushing a button.
 Recommended for professional craftsmen as well as DIY users.

- 1) Automatic calibration for easy and precise detection.
- 2) Graphic display indicates detected material.
- 3) IP54 protects from the rain and dirt when working outside.

Product specifications

Detectable materials /Max detection depth:	Cat. No.	
	DS-120	DS-100
Ferrous metal	120mm	100mm
Non-ferrous metal	80mm	
Live wiring	50mm	
Wooden studs	38mm	No
Display backlight	Yes	No
Working temperature (Celsius)	-10°C~+50°C	-10°C~+45°C
Storage temperature (Celsius)	-20°C~+70°C	
Weight	270g	260g
Dimension	200 x 86 x 32mm	
Original case	Yes	No
Power supply	1piece x 9 V 6LR61	

	Cat. No.	CTN (pcs.)	N.W. (kgs)	G.W. (kgs)	M3
DS-120		10	5	6	0.043
DS-100			6	7	

Durometer ~Hardness Gauge~

A "Durometer" is used for measuring the hardness of rubber products such as tires at a high accuracy.

The KDS durometer conforms to JIS and international standards and makes it possible to make measurement easily in a short time.

- 1) Functionally designed for compact and easy operation.
- 2) Dial face is graduated in equal, one degree increments for easy reading.
- 3) Magnesium alloy casing ensures long durability.

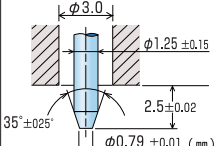
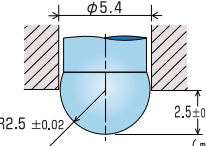

Product specifications

	Cat. No.	DM-104A	DM-204A	DM-107E	DM-207E
Type		Standard type	Two-hands type	Standard type	Two-hands type
Hardness indication		One degree for one gradation			
Accuracy		±1 deg.			
Weight		200g		225g	
Applicable Std.		JIS K 6253 ISO 7619 ASTM D 2240		JIS K 6253	
Meas Object		Ordinary rubber		Soft rubber	
Weight application		550-8050mN (56.1-821.1gf)			
Pointer					

	Cat. No.	CTN (pcs.)	N.W. (kgs)	G.W. (kgs)	M3
DM-104A		40	11	13	0.031
DM-204A					
DM-107E			12	14	
DM-207E					

Surveys

Auto Line Laser

High powered Laser unit. Water and dust proof (IP54). Micro-adjustment control screw.

Aluminum alloy Framework. One push button for adjusting vertical and horizontal lines.

ATL-65

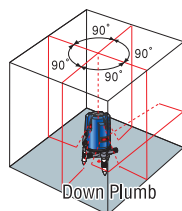

Laser Line of ATL-65

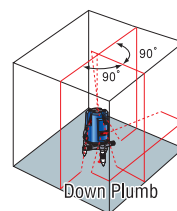

Laser Line of ATL-55

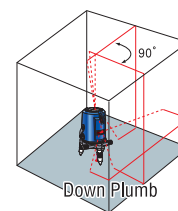

Laser Line of ATL-45

Technical Specifications

Model	ATL-65	ATL-55	ATL-45
Laser Diode	635nm (Down Plum Beam 650nm)		
Laser Class	1M (JIS C6802)		
Accuracy	±1mm / 5m		
Range (Interior)	10m		
Range (Exterior W / detector)	25m		
Leveling type	Pendulum (Self leveling ±4°)		
Weather Resistance	Water and dust proof IP54		
Operating temperature	-10°C ~ 40°C		
Battery type	Three (3) "AA" Alkaline batteries		
Operation time W / All Lines on	5 hours	6 hours	8 hours
Measurement / Weight	85 (φ) x 160mm (0.9kg)		

Automatic Level

RX Series

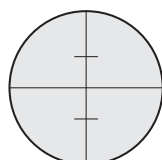

RX-26

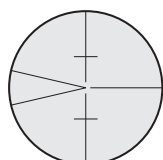

RX-28 / 32

Excellent workability with high weather resistance properties. Good Design and Compact size. 40mm wide objective aperture. Useful 0.5m minimum focus for interior work. Includes carrying case, plumb bob, hexagonal wrench, adjusting pin.

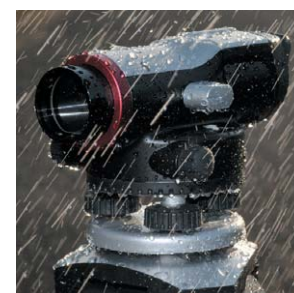

Specifications

Model	RX-26	RX-28	RX-32
Magnification	26x	28x	32x
Objective aperture	40mm		
Minimum Focus	0.5m		
Accuracy (Standard deviation for 1km double-run leveling)	±2.0mm		
Working Range	±15'		
Image :	Erect		
Weather Resistance	IP X6		
Minimum Division :	1° (1 gon)		
Weight	1.7kg		

Marking Tools / Straight Rules

Anchor Line

KDS® Anchor Lines are equipped with a strong magnet and replaceable needle for both steel and wooden construction.

Cat.No.	Length of Line	Plumb	QTY/Box	QTY/Carton	N.W.(kgs)	G.W.(kgs)	M3
SF-16B	4.5m	400g fixed	6	24	13	15	0.031

Accessories

Cat.No.	Description	Size	Weight	QTY/Carton	N.W.(kgs)	G.W.(kgs)	M3
AW-16-400	Plumb bob	124 x ø30	400g	12	5	7	0.008

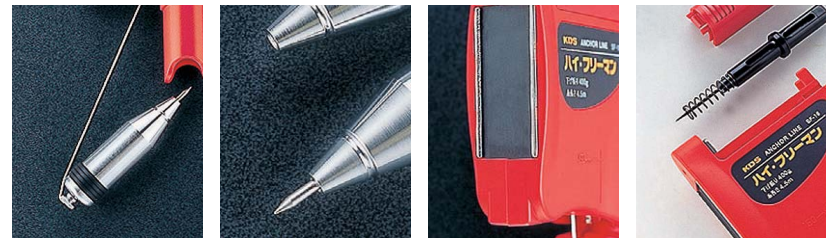

Straight Rules

Made from hardened and tempered steel. "HC-series" are supplied with an easy to read anti-glare chrome plated finish, which provides marked contrast to the permanent black figures and graduations. Stainless steel "SS-series" are also available for popular use.

Cat.No.	Length	Width	CTN (pcs.)	N.W. (kgs)	G.W. (kgs)	M3
Hard Chrome Plated						
HC1ME	150mm x 6"	15mm	300	11	13	0.020
HC3ME	300mm x 12"	25mm	200	14	15	0.010
HC6ME	600mm x 24"	30mm	80	15	16	0.007
HC10ME	1000mm x 36"	35mm	30	13	14	0.034
HC20ME	2000mm x 78"	40mm		38	40	0.029
Stainless Steel						
SS1ME	150mm x 6"	15mm	300	11	13	0.020
SS3ME	300mm x 12"	25mm	200	14	15	0.010
SS6ME	600mm x 24"	30mm	80	15	16	0.007
SS10ME	1000mm x 36"	35mm	30	13	14	0.029
SS15ME	1500mm x 60"	40mm		30	32	0.034
SS20ME	2000mm x 78"			38	40	0.034



Wooden Chisels / Planers



Wooden Chisels



KDS® chisel blade and tang are made from carbon steel and are tempered and beveled, with a tough, impact - resistant plastic handle. Available in standard tang, and in eight special types for crafts, wood carving, and other elaborate work.

Long Type						
Cat.No.	Width	CTN(Unit.)	N.W.(kgs)	G.W.(kgs)	M3	
EN-01BP	6mm	60	14	16	0.033	
EN-015BP	9mm	60	15	17	0.033	
EN-02BP	12mm	60	16	18	0.033	
EN-025BP	15mm	60	11	12	0.044	
EN-03BP	19mm	60	11	12	0.044	
EN-035BP	22mm	60	12	14	0.044	
EN-04BP	25mm	60	13	15	0.044	
EN-05BP	32mm	60	15	17	0.044	
EN-06BP	38mm	60	17	19	0.044	
EN-3SV	12, 19, 25mm	48 set	26	28	0.042	
EN-4SV	6, 12, 19, 25mm	32 set	22	24	0.038	
EN-6SV	6, 12, 15, 19, 25, 32mm	24 set	27	29	0.049	
Special type						
Cat.No.	Type	Width	CTN(Unit.)	N.W.(kgs)	G.W.(kgs)	M3
No.3101	flat	9mm	100	10	12	0.041
No.3103	flat	15mm	100	10	12	0.041
No.3104	shallow gouge	9mm	100	10	12	0.041
No.3105	gouge	9mm	100	10	12	0.041
No.3106	gouge	12mm	100	10	12	0.041
No.3107	v-parting	9mm	100	10	12	0.041
No.3108	bent gouge	9mm	100	10	12	0.041
No.3109	skew	9mm	100	10	12	0.041
No.3166	6pce. Set No.3101, No.3103, No.3105, No.3106, No.3107, No.3109		24 set	15	17	0.050
No.3168	8pce. Set No.3101, No.3103, No.3104, No.3105, No.3106, No.3107, No.3108, No.3109		24 set	21	23	0.067



Planers



KDS® brand planes are made from high grade carbon steel with a Japanese white oak body. No.5710 for chamfer molding, No.5720 for round molding, and No.5730 for mini smooth are replaceable and can be sharpened for longer use. Available in a range of sizes for elaborate work. Available only in Japanese version.

Cat.No.	Blade	CTN(Unit.)	N.W.(kgs)	G.W.(kgs)	M3
No.5710	30mm	60	18	20	0.047
No.5720	30mm	60	14	16	0.033
No.5730	30mm	60	14	16	0.033
No.5742	42mm	30	11	13	0.023
No.5748	48mm	30	15	17	0.024
No.5750	50mm	20	15	17	0.024
No.5758	58mm	20	19	21	0.003
No.5760	60mm	20	19	21	0.003